

Road Network Performance & Research Team

RNPR Traffic Note 8 June 2007

Proportion of Cyclists Who Violate Red Lights in London



Précis:

A summary and investigation into anecdotal evidence regarding the proportion of cyclists jumping red lights at junctions. It investigates the hypothesis that the majority of cyclists do ride through red lights, and that there is a gender divide.

Contents

| | |
|---|----|
| Contents..... | 1 |
| Tables | 1 |
| Figures..... | 1 |
| 1 Introduction | 2 |
| 2 Site 1 - Vauxhall Bridge | 5 |
| 3 Site 2 – Balham High Road..... | 10 |
| 4 Site 3 - Brixton Hill..... | 15 |
| 5 Site 4 - Camberwell New Road..... | 20 |
| 6 Site 5 - Greenwich South Street..... | 25 |
| 7 Summary..... | 28 |
| 8 Library of technical notes | 31 |
| 9 Contacts for further information..... | 32 |

Tables

| | |
|--|----|
| Table 1 - All cyclists using Vauxhall Bridge during the morning and evening peaks | 5 |
| Table 2 – Proportion of male and female cyclists who disobeyed red lights at Vauxhall Bridge..... | 5 |
| Table 3 – Comparison of cyclists that violated traffic signals at each arm of Vauxhall Bridge..... | 6 |
| Table 4 - All cyclists using Balham High Road during the morning and evening peaks | 10 |
| Table 5 – Proportion of male and female cyclists who disobeyed red lights at Balham High Road..... | 10 |
| Table 6 - Comparison of cyclists that violated traffic signals at each arm of Balham High Road..... | 11 |
| Table 7 – All cyclists using Brixton Hill during the morning and evening peaks..... | 15 |
| Table 8 – Proportion of male and female cyclists who disobeyed red lights at Brixton Hill..... | 15 |
| Table 9 - Comparison of cyclists that violated traffic signals at each arm of Brixton Hill | 16 |
| Table 10 – All cyclists using Camberwell Road during the morning and evening peaks | 20 |
| Table 11 – Proportion of male and female cyclists who disobeyed red lights at Camberwell Road | 20 |
| Table 12 – Comparison of cyclists that violated traffic signals at each arm of Camberwell Road | 21 |
| Table 13 – All cyclists using Greenwich South Street during the morning and evening peaks..... | 25 |
| Table 14 – Proportion of male and female cyclists who disobeyed red lights at Greenwich South St. | 25 |
| Table 15 – Number of cyclists that violated each arm at Greenwich South Street | 26 |
| Table 16 – Summary of the proportion of cyclist violations at each site | 28 |
| Table 17 – Summary of the proportion of male and female cyclists that violated red lights | 28 |
| Table 18 – Proportion of turning movements by male and female red light violators | 29 |

Figures

| | |
|--|----|
| Figure 1 – Long term trend in cordon crossings for cyclists 1986 to 2006..... | 3 |
| Figure 2 – Locations of cycle survey sites..... | 4 |
| Figure 3 - Proportion of cyclists who violated red lights at Vauxhall Bridge by time and gender | 7 |
| Figure 4 - Proportion of cyclists who did not violate red lights at Vauxhall Bridge by time and gender . | 7 |
| Figure 5 – Difference in the turning direction of red light violators..... | 8 |
| Figure 6 - Proportion of cyclists who violated red lights at Balham High Road by time and gender | 12 |
| Figure 7 - Proportion of cyclists who did not violate red lights at Balham High Rd by time and gender | 12 |
| Figure 8 - Difference in the turning direction of red light violators..... | 13 |
| Figure 9 –Proportion of cyclists who violated red lights at Brixton Hill by time and gender | 17 |
| Figure 10 – Proportion of cyclists who did not violate red lights at Brixton Hill by time and gender..... | 17 |
| Figure 11 - Difference in the turning direction of red light violators..... | 18 |
| Figure 12 - Proportion of cyclists who violated red lights at Camberwell Rd by time and gender..... | 22 |
| Figure 13 - Proportion of cyclists who did not violate red lights at Camberwell Rd by time and gender | 22 |
| Figure 14 - Difference in the turning direction of red light violators..... | 23 |
| Figure 15 – Proportion of male cyclists who violated or did not violate red lights at Greenwich South Street by time of day..... | 26 |
| Figure 16 – Difference in the turning direction of male red light violators | 27 |

1 Introduction

- 1.1 This traffic note, produced by the Road Network Performance and Research (RNPR) Team within TfL provides a summary and analysis of the proportion of cyclists who ride through red lights. There is anecdotal evidence that a significant proportion of cyclists disobey the law and cycle through red lights. This report sets out to test this hypothesis by analysing cycle counts taken at five arbitrarily selected junctions in south London.
- 1.2 Articles have emerged recently in *The Times*, *The Guardian* and *The Evening Standard* stating that women are more likely to be killed or seriously injured while cycling as they obey the law and wait whilst traffic lights are red. The media claim that this is supported by an unpublished TfL report which states that 86% of female cyclist fatalities in London involved a heavy goods vehicle turning left at a junction. This traffic note sets out to test a second hypothesis by distinguishing the gender of cyclists that ride through red lights.
- 1.3 This report also sets out to test a third hypothesis that the volume of cyclists who jump red lights varies according to time of day. As such the report examines the differences in the number of violations in the morning and evening peaks. Variations in cyclists turning direction will also be examined in order to establish any influence this may have.
- 1.4 Cycle counts were taken at five sites across south London. These locations are shown in Figure 2 on page 4.
- 1.5 The five sites were:
- Vauxhall Bridge junction with Millbank, Vauxhall Bridge and Grosvenor Road
 - Balham High Road junction with Tooting Bec Road, Tooting Road and Trinity Road
 - Brixton Hill junction with Christchurch Road, Streatham Hill and Streatham Place
 - Camberwell Road junction with, Camberwell Church Street, Denmark Hill and Camberwell New Road
 - Greenwich South Street junction with Blackheath Hill, Lewisham Road and Blackheath Road
- 1.6 The time periods referred to and summarised for the purposes of this note are:
- Morning peak: 7:00am – 10:00am
- Evening peak 4:00pm – 7:00pm
- All count periods are for weekdays.
- 1.7 The purpose of this report is to see whether anecdotal evidence is correct and that, with high levels of cyclists the number of cyclists cycling through red lights is becoming a road safety issue. This will be analysed further by differentiating by gender and time of day.
- 1.8 A map showing the location of surveyed sites is at in Figure 2 overleaf.

- 1.9 Manual surveys were taken on every arm of each selected site in order to measure the number of violations. A violation was defined as a cyclists crossing though a red light, and continuing over or turning at a junction. As such, a violation was not merely deemed to be crossing the stop line. However, the results may be subjective to judgement of individual surveyors.
- 1.10 Regular surveys are undertaken at three different cordons within Greater London. As the survey programme is based on a three-year rolling programme periods vary for each cordon. Figure 1 overleaf shows the long term trend in cyclists crossing these cordons, based on 24 hour combined direction flows. Cyclist traffic crossing the central cordon has increased dramatically in the last 20 years, especially since 2001. Cyclist traffic crossing the inner cordon has also risen, although at a much slower rate. Conversely cyclist traffic crossing the boundary cordon decreased over the last 20 years before stabilising in 1998.
- 1.11 This increase in cycling activity has also been seen on a London-wide scale. The number of cyclists on the TLRN has increased by 83% since 2000. This has led to an estimated 480,000 cycle journeys every day across London.

Figure 1 – Long term trend in cordon crossings for cyclists 1986 to 2006

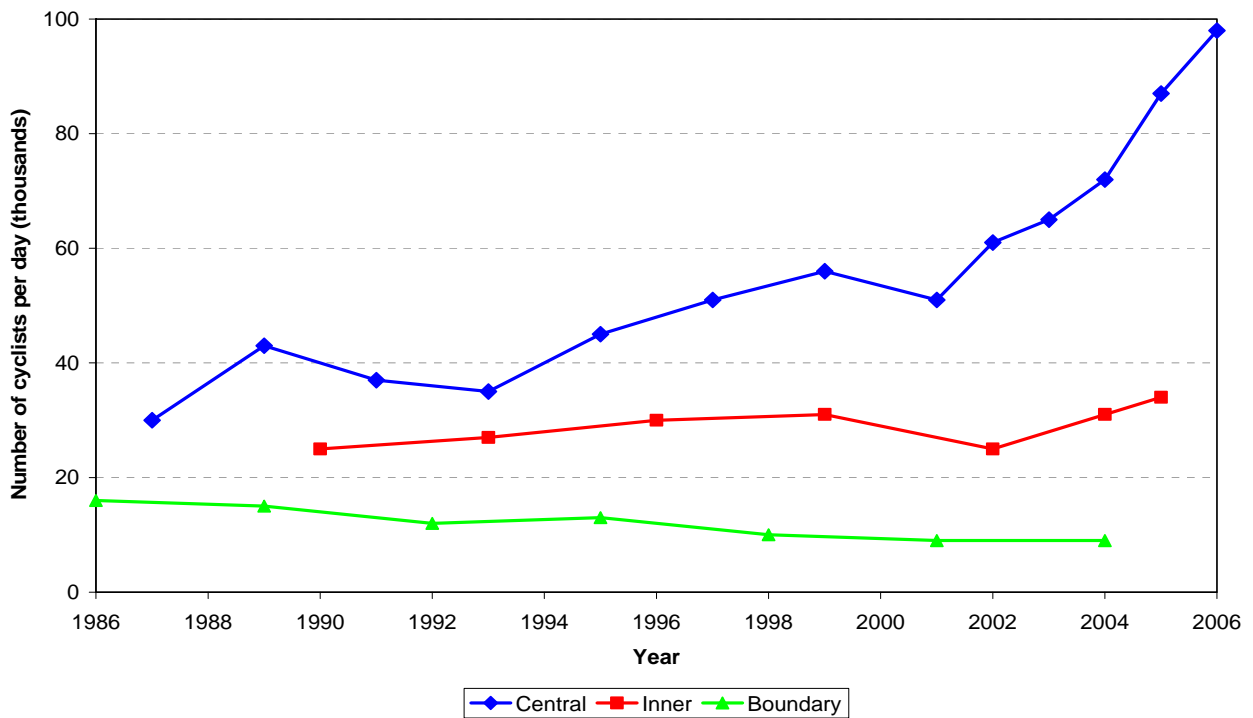

- 1.12 Greater detail about cycle flows in London can be found in RNPR Traffic Note 3 – TfL Cordon and Screenline Surveys 1971-2006. See Section 8 for further details.

Note: These 5 junctions provide a small sample only and provide indicative results. A much larger and geographically spread sample would be required to provide statistically reliable results.

Figure 2 – Locations of cycle survey sites

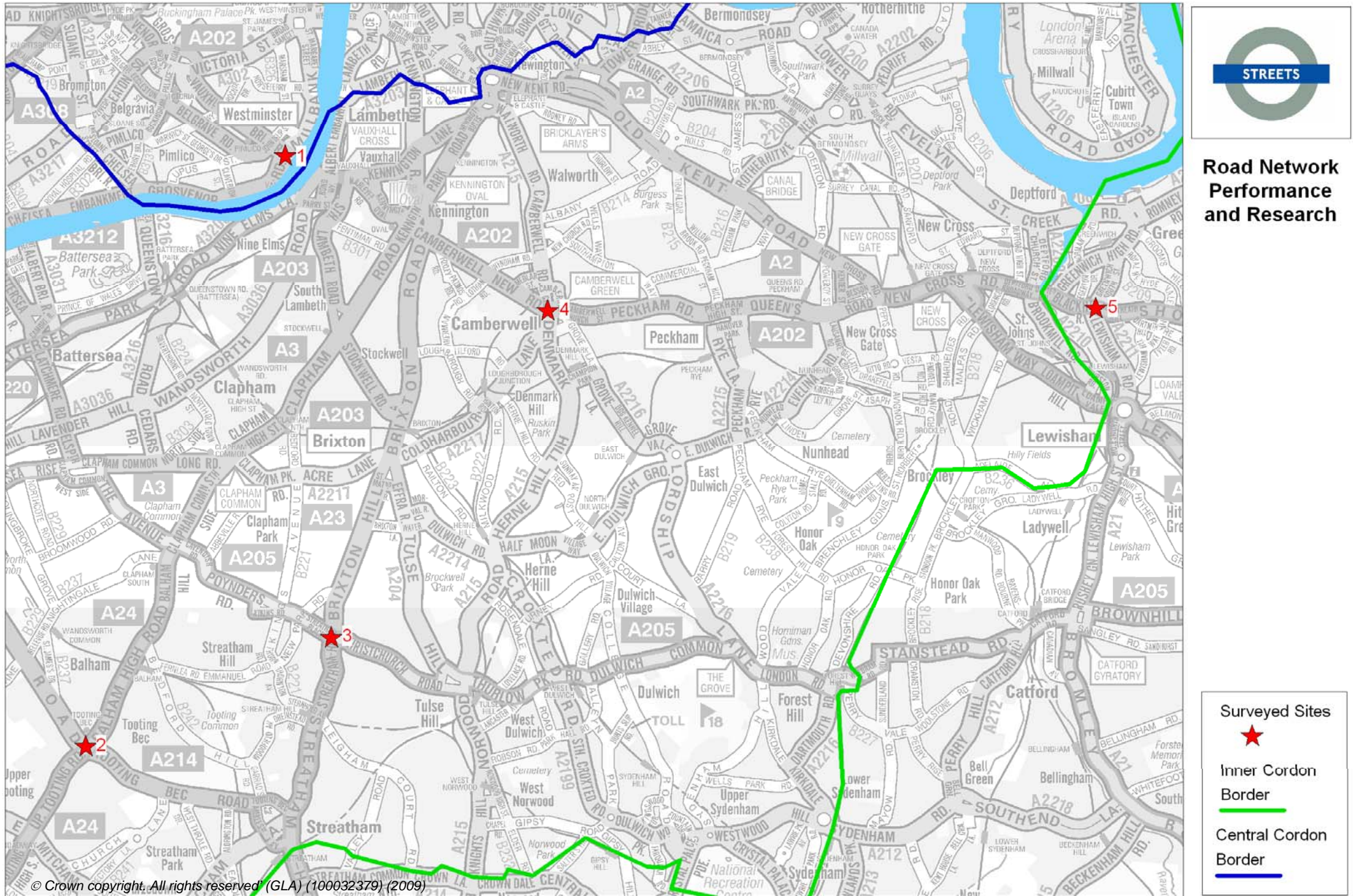

2 Site 1 - Vauxhall Bridge

2.1 This section provides a summary and analysis of cyclists riding through red lights at site 1, as surveyed in June 2007. Table 1, below, shows the total number of cyclists that used each arm of Site 1 during the surveyed hours.

Table 1 - All cyclists using Vauxhall Bridge during the morning and evening peaks

| | Total number of cyclists | | | | | | | |
|----------------|--------------------------|---------------|---------------|---------------|---------------|---------------|---------------|---------------|
| | Arm A | | Arm B | | Arm C | | Arm D | |
| | Non-Violation | Non-Violation | Non-Violation | Non-Violation | Non-Violation | Non-Violation | Non-Violation | Non-Violation |
| Total Cyclists | 117 | 688 | 191 | 875 | 67 | 839 | 83 | 652 |
| % Cyclists | 15 | 85 | 18 | 82 | 7 | 93 | 11 | 89 |

Please note that arms are as follows: Arm A – Millbank; Arm B – Vauxhall Bridge; Arm C – Grosvenor Road; Arm D – Bessborough Gardens

2.2 Table 1 shows that the majority of cyclists obeyed the red lights at site 1. Of the 3512 cyclists that used the junction during the surveyed hours an average of 87% of cyclists did not violate red lights. As such, the anecdotal evidence that most cyclists ride through red lights cannot be attributed to this site.

Table 2 – Proportion of male and female cyclists who disobeyed red lights at Vauxhall Bridge

| | Number of cyclists | | | | | |
|----------------|--------------------|---------------|-------|---------------|---------------|-------|
| | All Arms | | | | | |
| | Male | | | Female | | |
| | Non-Violation | Non-Violation | Total | Non-Violation | Non-Violation | Total |
| Total Cyclists | 366 | 2253 | 2619 | 92 | 801 | 893 |
| % Cyclists | 14 | 86 | 100 | 10 | 90 | 100 |

2.3 Table 2 shows that nearly three times as many male cyclists used the junction during the surveyed hours than female cyclists with a total of 2619 and 893 cyclists respectively. There is little difference between the proportion of men and women who violated red lights, with 14% of men and 10% of women doing so. As such the hypothesis that men are more likely to ride through red lights than women is correct for this junction. Table 3 shows the variation between each arm.

Table 3 – Comparison of cyclists that violated traffic signals at each arm of Vauxhall Bridge

| Total number of cyclists during the AM and PM peaks | | | | | | | | |
|---|----------|--------------|----------|--------------|----------|--------------|----------|--------------|
| | Arm A | | | | Arm B | | | |
| | Male | | Female | | Male | | Female | |
| | Violator | Non-Violator | Violator | Non-Violator | Violator | Non-Violator | Violator | Non-Violator |
| | | | | | | | | |
| Total Cyclists | 98 | 524 | 19 | 164 | 145 | 629 | 46 | 246 |

| | Arm C | | | | Arm D | | | |
|----------------|----------|--------------|----------|--------------|----------|--------------|----------|--------------|
| | Male | | Female | | Male | | Female | |
| | Violator | Non-Violator | Violator | Non-Violator | Violator | Non-Violator | Violator | Non-Violator |
| | | | | | | | | |
| Total Cyclists | 51 | 660 | 16 | 179 | 72 | 440 | 11 | 212 |

Please note that arms are as follows: Arm A – Millbank; Arm B – Vauxhall Bridge; Arm C – Grosvenor Road; Arm D – Bessborough Gardens

2.4 Table 3 shows the total number of cyclists who either violated or respected red lights during both the AM and PM peaks. Whilst the majority of cyclists did obey the traffic signals at each arm, there are differences in the numbers of male and female cyclists that did so. However, as there were also differences in the numbers of male and female cyclists using the junction, the proportion of men and women violating red lights is similar. Further analysis can be found in Figure 3 and Figure 4 below.

Figure 3 - Proportion of cyclists who violated red lights at Vauxhall Bridge by time and gender

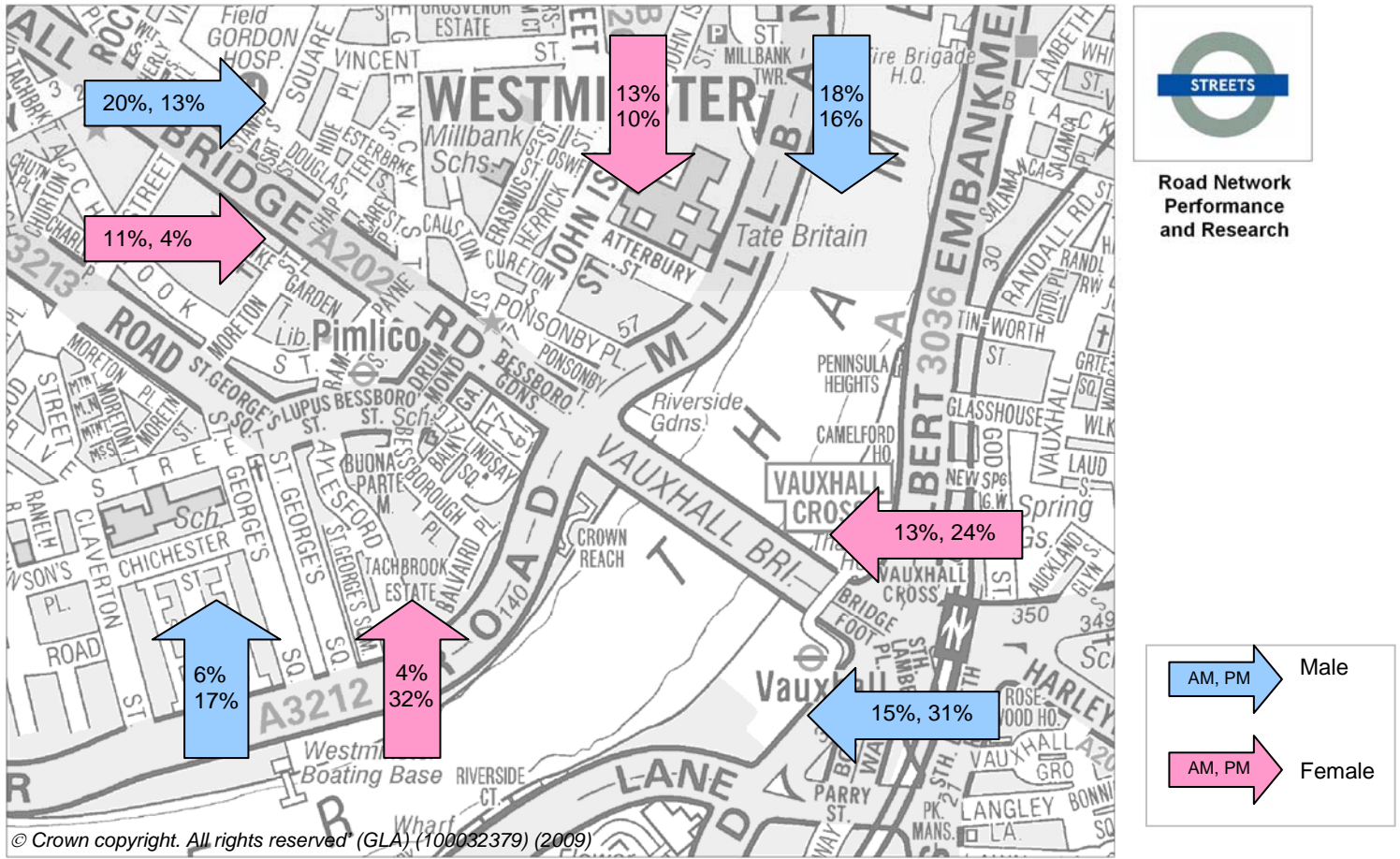
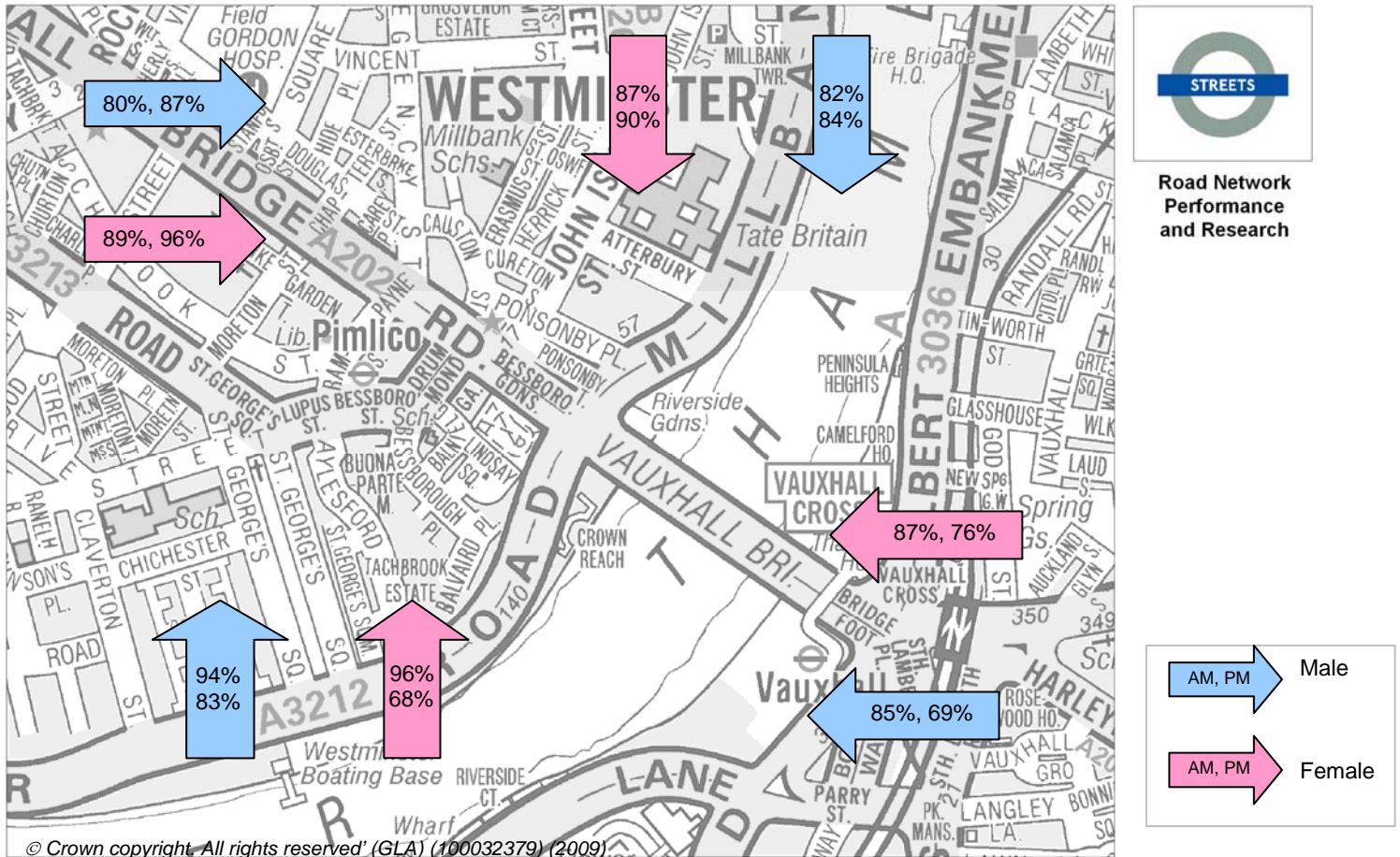
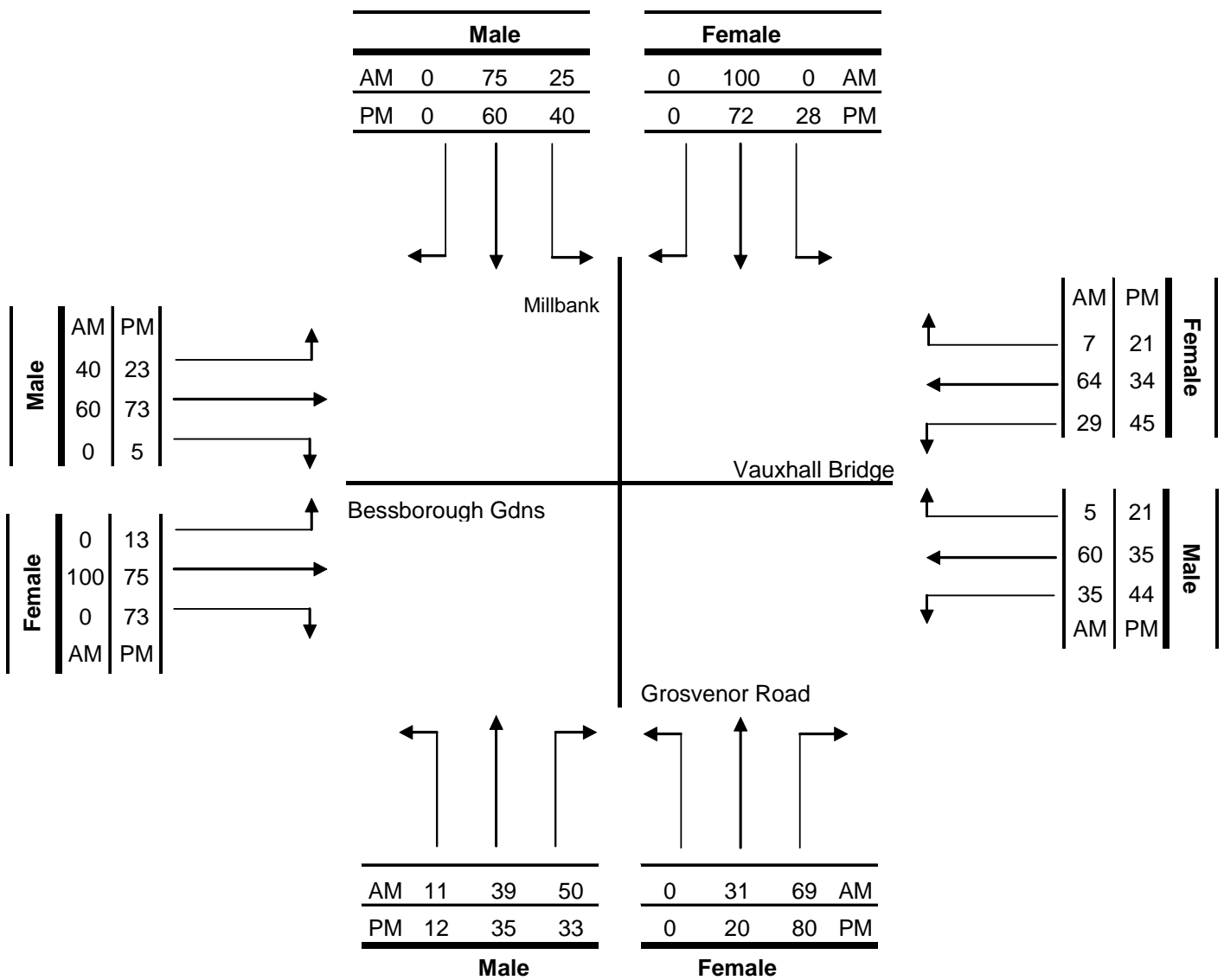

Figure 4 - Proportion of cyclists who did not violate red lights at Vauxhall Bridge by time and gender



- 2.5 Figure 3 shows a comparison of the proportion of male and female cyclists that violated traffic lights on the day of the survey. In all but one instance a greater proportion of men than women did not obey the red light, supporting the evidence shown in Table 3
- 2.6 Generally speaking, a much larger proportion of cyclists of both genders ran through a red light during the PM peak than in the AM peak. In some cases nearly a third of cyclists ran the red lights in the evening peak, compared with between 4% and 15% in the morning. This demonstrates that red light jumping does vary by time of day, and may be as a result of the levels of motorised traffic flows at those particular times.
- 2.7 Arm D is the one exception of this, where both male and female cyclists jumped more red lights in the AM rather than the PM peak. The majority of cyclists using this arm were moving away from central London. These results indicate cyclists are more likely to run red lights in the non-peak direction.
- 2.8 The relationship between red light violation and turning direction is shown below in Figure 5.

Figure 5 – Difference in the turning direction of red light violators



- 2.9 Figure 5 shows a break down of the turning directions of the cyclists that jumped red lights at site 1. On three arms (Millbank, Vauxhall Bridge and Bessborough Gardens) the majority of cyclist who jumped red lights were moving straight over at the junction, and very few, in some cases none, turned right. In contrast however, on arm C the majority of cyclists who jumped red lights were turning right onto Vauxhall Bridge.
- 2.10 There are also differences according to time of day. For example, on Vauxhall Bridge the majority (60%) of female cyclists who jumped red lights in the morning peak rode straight ahead at the junction. However, in the evening peak, the majority (45%) turned left onto Grosvenor Road. A similar pattern emerged with the male cyclists that used this arm.

Other Issues

- 2.11 One surveyor noted that a cyclist on a recumbent bike moving across the junction from Millbank onto Grosvenor Road was almost killed by a van turning left onto Vauxhall Bridge. Whilst the cyclist obeyed the traffic signals, the van went through on amber.
- 2.12 Another noted that any cyclist violating the red lights between Vauxhall Bridge and Grosvenor Road was also travelling over a 'green' pedestrian crossing on Grosvenor Road. This is obviously worrying as anyone crossing here could potentially be injured.

3 Site 2 – Balham High Road

3.1 This section provides a summary and analysis of cyclists riding through red lights at site 2, as surveyed in May 2007. Table 4, below, shows the total number of cyclists that used each arm of Site 2 during the surveyed hours. No figures are shown for arm C as no cyclists entered the junction from that arm.

Table 4 - All cyclists using Balham High Road during the morning and evening peaks

| | Total number of cyclists | | | | | | | |
|----------------|--------------------------|---------------|-----------|---------------|-----------|---------------|-----------|---------------|
| | Arm A | | Arm B | | Arm D | | Arm E | |
| | Violation | Non-Violation | Violation | Non-Violation | Violation | Non-Violation | Violation | Non-Violation |
| Total Cyclists | 41 | 267 | 58 | 134 | 9 | 327 | 25 | 151 |
| % Cyclists | 13 | 87 | 30 | 70 | 3 | 97 | 14 | 86 |

Please note that arms are as follows: Arm A – Balham High Road; Arm B – Tooting Bec Road; Arm C – Stapleton Road; Arm D – Upper Tooting Road; Arm E – Trinity Road

3.2 Table 4 shows that the majority of cyclists obeyed the red lights and did not run through them. Of the 1012 cyclists that used the junction during the surveyed hours an average of 87% of cyclists did not violate red lights. As such the anecdotal evidence that most cyclists ride through red lights cannot be attributed to this site.

Table 5 – Proportion of male and female cyclists who disobeyed red lights at Balham High Road

| | Number of cyclists | | | | | |
|----------------|--------------------|---------------|-------|-----------|---------------|-------|
| | All Arms | | | | | |
| | Male | | | Female | | |
| | Violation | Non-Violation | Total | Violation | Non-Violation | Total |
| Total Cyclists | 111 | 665 | 776 | 22 | 214 | 236 |
| % Cyclists | 14 | 86 | 100 | 9 | 91 | 100 |

3.3 Table 5 shows that over three times as many male cyclists used the junction during the surveyed hours than female cyclists with a total of 776 and 236 cyclists respectively. There is little difference between the proportion of men and women that violated red lights, with the vast majority of both genders obeying the traffic signals. However slightly more men did ignore the traffic signals; as such, evidence from this junction supports the hypothesis that men are more likely to violate red lights to some extent. Table 6 shows the variations between each arm. Once again no figures are shown for arm C as cyclists only entered the arm and did not exit it.

Table 6 - Comparison of cyclists that violated traffic signals at each arm of Balham High Road

| Total number of cyclists during the AM and PM peaks | | | | | | | | |
|---|----------------|--------------|----------|--------------|----------|--------------|----------|--------------|
| | Arm A | | | | Arm B | | | |
| | Male | | Female | | Male | | Female | |
| | Violator | Non-Violator | Violator | Non-Violator | Violator | Non-Violator | Violator | Non-Violator |
| | Total Cyclists | 30 | 202 | 11 | 65 | 52 | 102 | 6 |

| | Arm D | | | | Arm E | | | |
|--|----------------|--------------|----------|--------------|----------|--------------|----------|--------------|
| | Male | | Female | | Male | | Female | |
| | Violator | Non-Violator | Violator | Non-Violator | Violator | Non-Violator | Violator | Non-Violator |
| | Total Cyclists | 8 | 261 | 1 | 66 | 21 | 100 | 4 |

Please note that arms are as follows: Arm A – Balham High Road; Arm B – Tooting Bec Road; Arm D – Upper Tooting Road; Arm E – Trinity Road

3.4 Table 6 shows the total number of cyclists who either violated or respected red lights during both the AM and PM peaks. Whilst the majority of cyclists did obey the traffic signals at each arm, there are differences in the number of male and female cyclists that did so. On the whole slightly more men jumped red lights than women, although the proportion varies at each arm. At arm D just seven more men than women violated the red lights. In contrast at arm B forty six more men did so. Further analysis can be found in Figure 6 and Figure 7 below.

Figure 6 - Proportion of cyclists who violated red lights at Balham High Road by time and gender

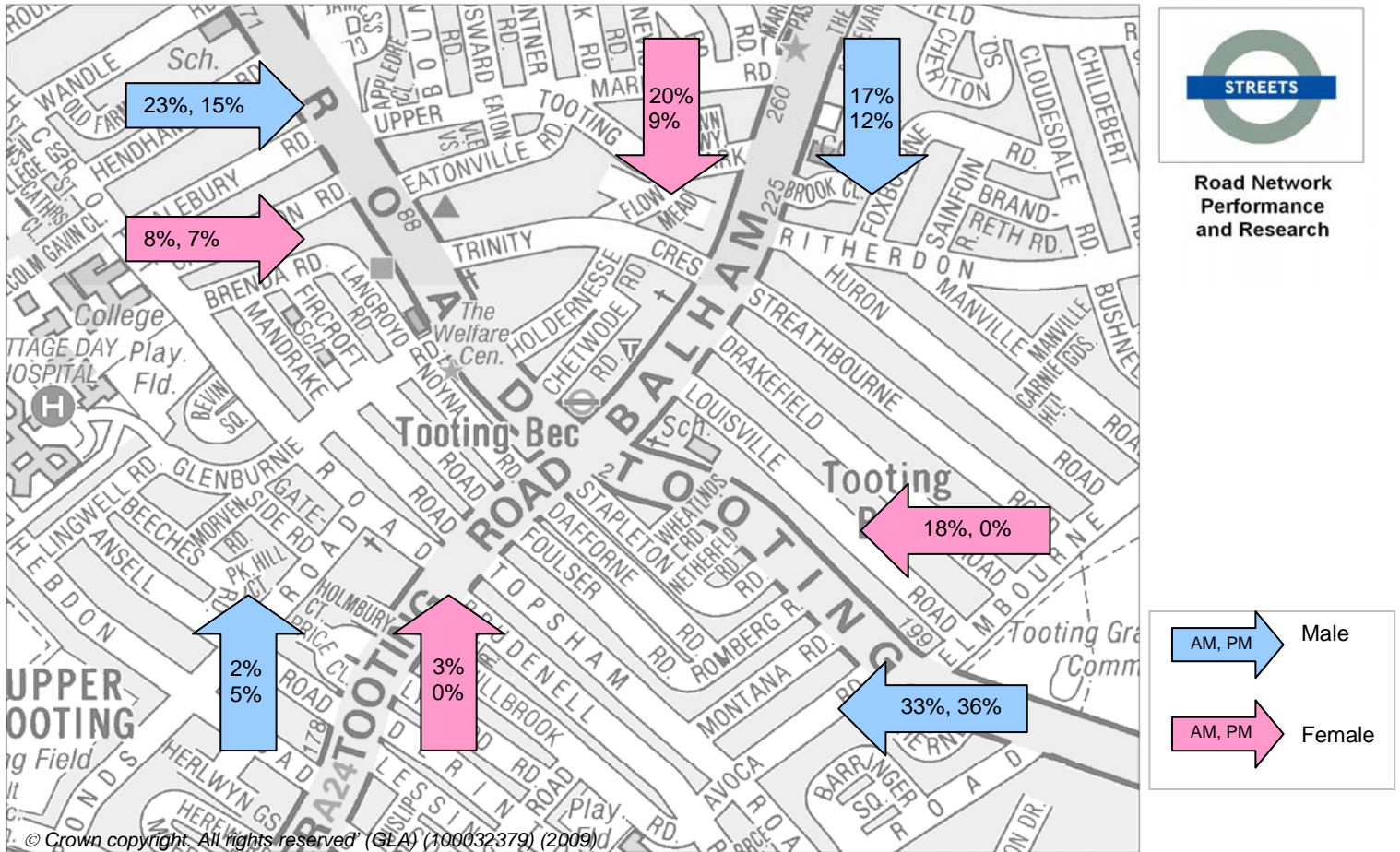
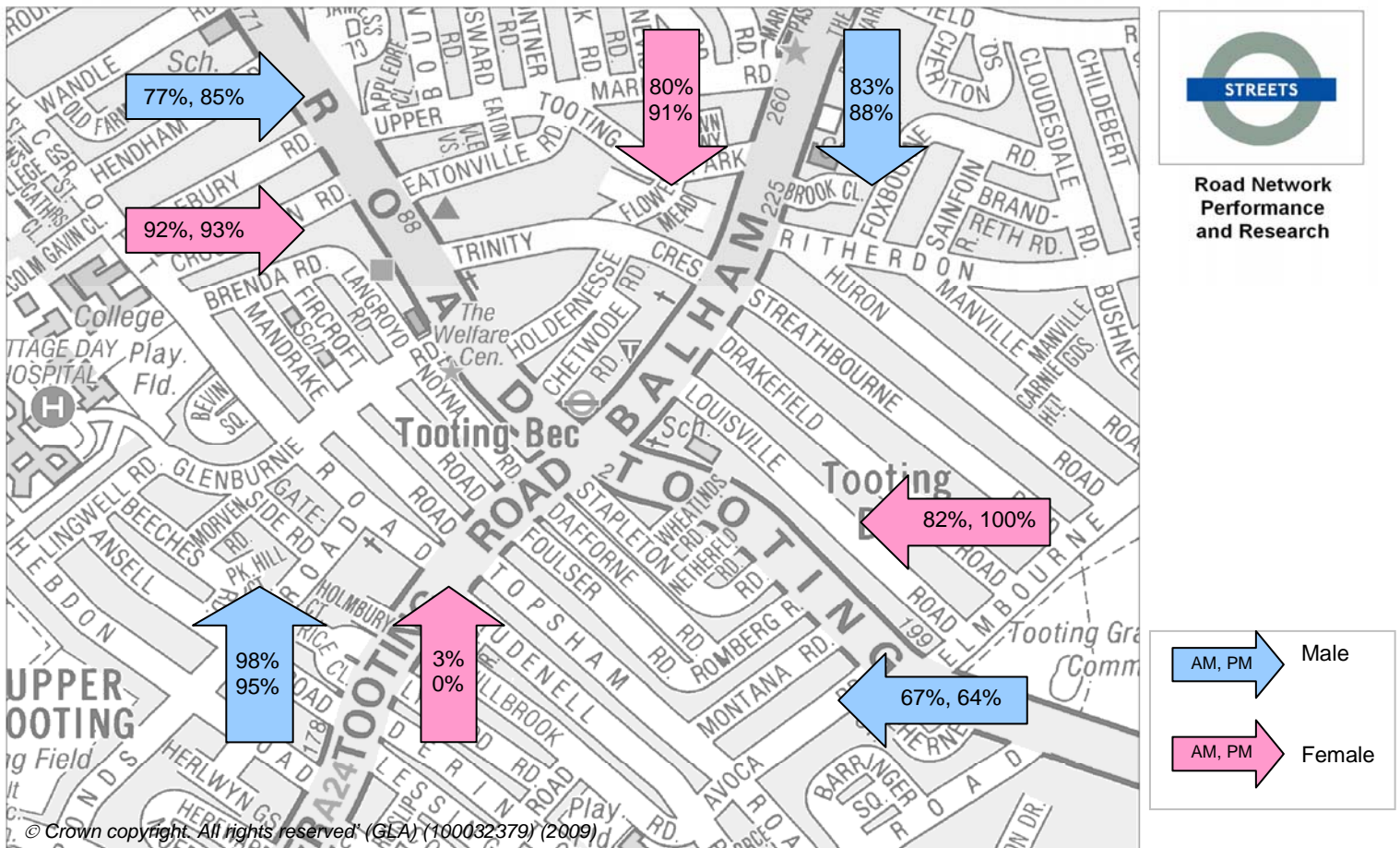
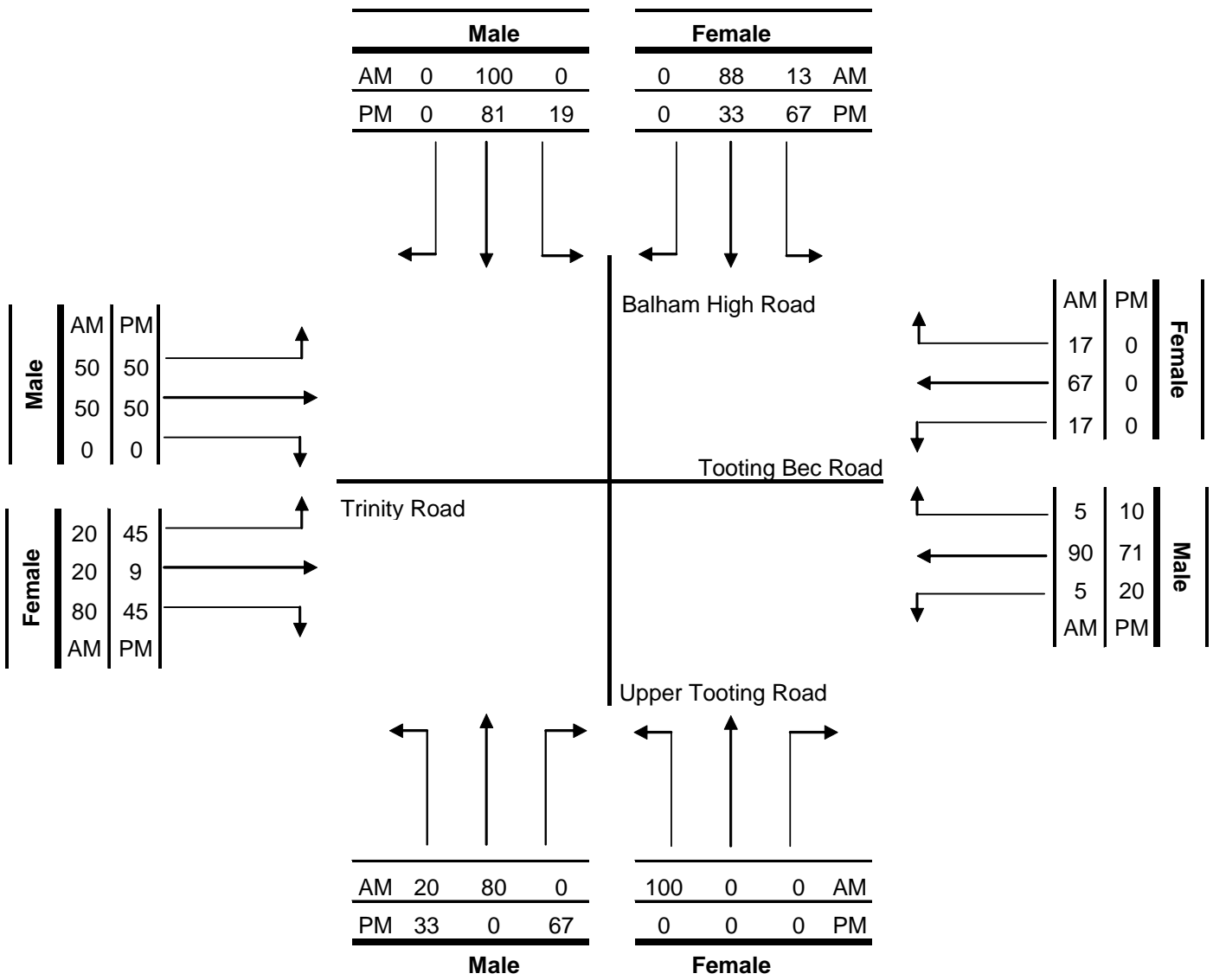

Figure 7 - Proportion of cyclists who did not violate red lights at Balham High Rd by time and gender



- 3.5 Figure 6 shows a comparison of the proportion of male and female cyclists that violated traffic lights on the day of the survey. In all but two instances a greater proportion of men than women did not obey the red light, supporting the evidence shown in Table 6.
- 3.6 Generally speaking, more cyclists of both genders ran through red lights during the AM peak than the PM peak. The only occasions that more cyclists ran red lights in the PM peak were male cyclists on Arms B and D. In both instances traffic counted was moving towards London. This somewhat supports the hypothesis that red light jumping varies by time of day, and may reflect lower traffic levels at those particular arms and in those particular non-peak directions.

Figure 8 - Difference in the turning direction of red light violators



Note: Figures are not shown for Stapleton Road as no cyclists entered the junction from that arm and very few cyclists entered the street

- 3.7 Figure 8 shows a breakdown of the turning directions of the cyclists that jumped red lights at site 2. There is a marked difference on each arm in the turning movements of those cyclists that ran through red lights. For example, the majority of cyclists that jumped red lights on Balham High Road and Tooting Bec Road travelled straight ahead at the junction. However this was not true for female cyclists on Balham High Road in the PM peak, as the majority turned left.
- 3.8 For all arms the majority of men who rode through red lights turned right, whilst the majority of women went straight ahead. There was a much larger range of turning movements by females on Trinity Road than any other arm of the junction. For Tooting Bec Road in the morning peak the majority of male red light violators went straight, whilst in the evening the majority turned right. However, only one woman chose to disobey the traffic lights, turning left in the morning peak whilst doing so.

4 Site 3 - Brixton Hill

4.1 This section provides a summary and analysis of cyclists riding through red lights at site 3, as surveyed in May 2007. Table 7, below, shows the total number of cyclists that used each arm of Site 3 during the surveyed hours.

Table 7 – All cyclists using Brixton Hill during the morning and evening peaks

| | Total number of cyclists | | | | | | | |
|----------------|--------------------------|---------------|-----------|---------------|-----------|---------------|-----------|---------------|
| | Arm A | | Arm B | | Arm C | | Arm D | |
| | Violation | Non-Violation | Violation | Non-Violation | Violation | Non-Violation | Violation | Non-Violation |
| Total Cyclists | 52 | 153 | 45 | 103 | 46 | 323 | 24 | 96 |
| % Cyclists | 25 | 75 | 30 | 70 | 12 | 88 | 20 | 80 |

Please note that arms are as follows: Arm A – Brixton Hill; Arm B – Christchurch Road; Arm C – Streatham Hill; Arm D – Streatham Place

4.2 Table 7 shows that the vast majority of cyclists obeyed the traffic lights at Site 3. Of the 842 cyclists that used the junction during the surveyed hours an average of 80% of cyclists did not violate the red lights. As such the anecdotal evidence that most cyclists ride through red lights cannot be attributed to this site. However, of the cyclists that did ride through red lights, there was a marked difference in gender, as shown in Table 8.

Table 8 – Proportion of male and female cyclists who disobeyed red lights at Brixton Hill

| | Number of cyclists | | | | | |
|----------------|--------------------|---------------|-------|-----------|---------------|-------|
| | All Arms | | | | | |
| | Male | | | Female | | |
| | Violation | Non-Violation | Total | Violation | Non-Violation | Total |
| Total Cyclists | 142 | 523 | 665 | 25 | 152 | 177 |
| % Cyclists | 21 | 79 | 100 | 14 | 86 | 100 |

4.3 Table 8 shows that a total of 665 male cyclists used the crossroads during the surveyed hours at site 3, a figure nearly four times higher than female cyclists. Of the male cyclists, 79% obeyed the red lights and 21% rode through them. This compares with the 86% of female cyclists who waited at the red lights, and just 14% riding through them. Whilst it is not possible to propose why, this suggests that men are more likely to jump red lights than women.

Table 9 - Comparison of cyclists that violated traffic signals at each arm of Brixton Hill

| Total number of cyclists during the AM and PM peaks | | | | | | | | |
|---|----------------|--------------|----------|--------------|----------|--------------|----------|--------------|
| | Arm A | | | | Arm B | | | |
| | Male | | Female | | Male | | Female | |
| | Violator | Non-Violator | Violator | Non-Violator | Violator | Non-Violator | Violator | Non-Violator |
| | Total Cyclists | 46 | 124 | 6 | 29 | 38 | 76 | 7 |

| | Arm C | | | | Arm D | | | |
|--|----------------|--------------|----------|--------------|----------|--------------|----------|--------------|
| | Male | | Female | | Male | | Female | |
| | Violator | Non-Violator | Violator | Non-Violator | Violator | Non-Violator | Violator | Non-Violator |
| | Total Cyclists | 37 | 259 | 9 | 64 | 21 | 64 | 3 |

4.4 Table 9 shows the total number of cyclists who either violated or respected red lights during both the AM and PM peaks. The majority of both male and female cyclists respected red lights an all arms of the junction. Further analysis of this can be found in Figure 9 and Figure 10 below.

Figure 9 –Proportion of cyclists who **violated** red lights at Brixton Hill by time and gender

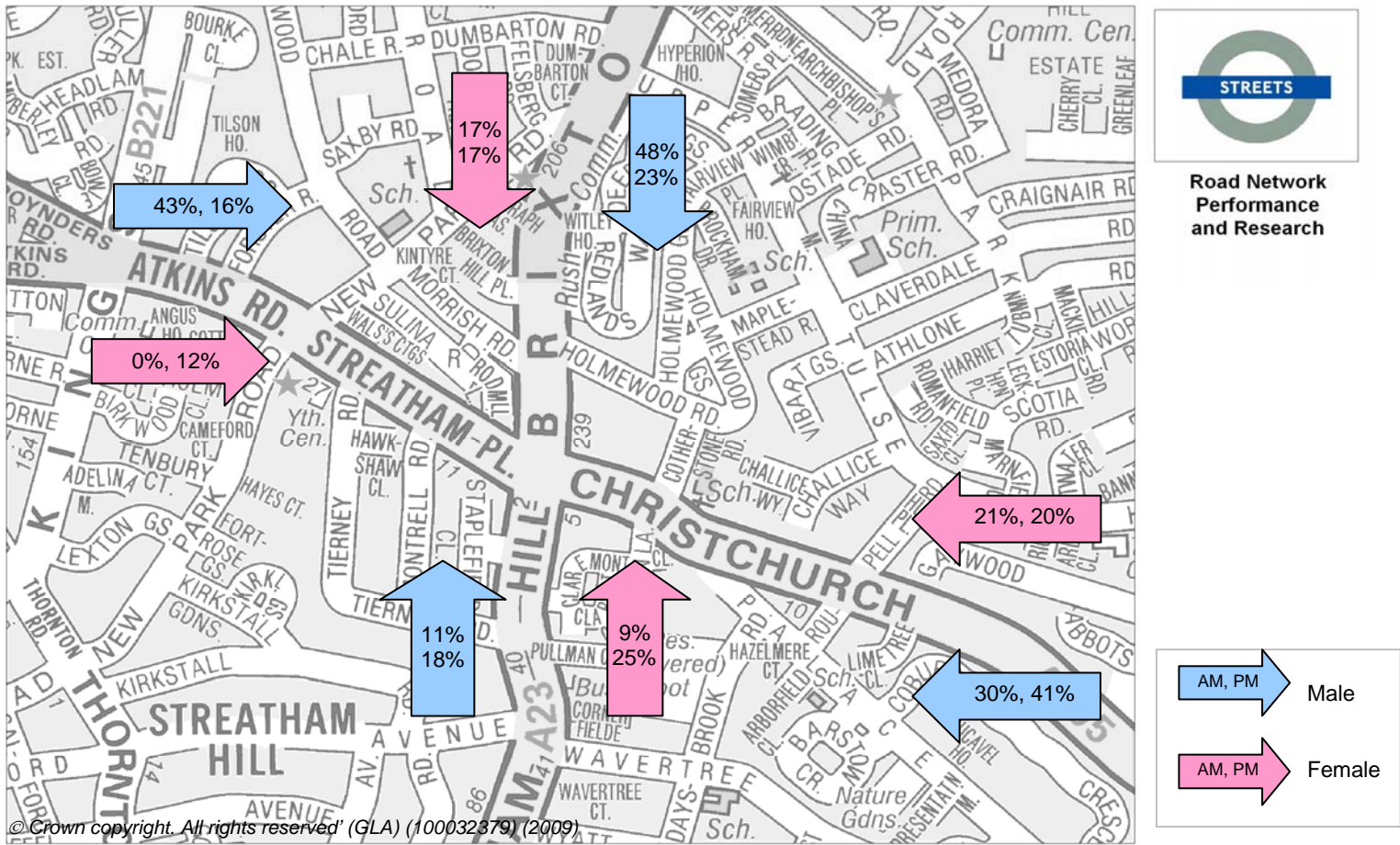
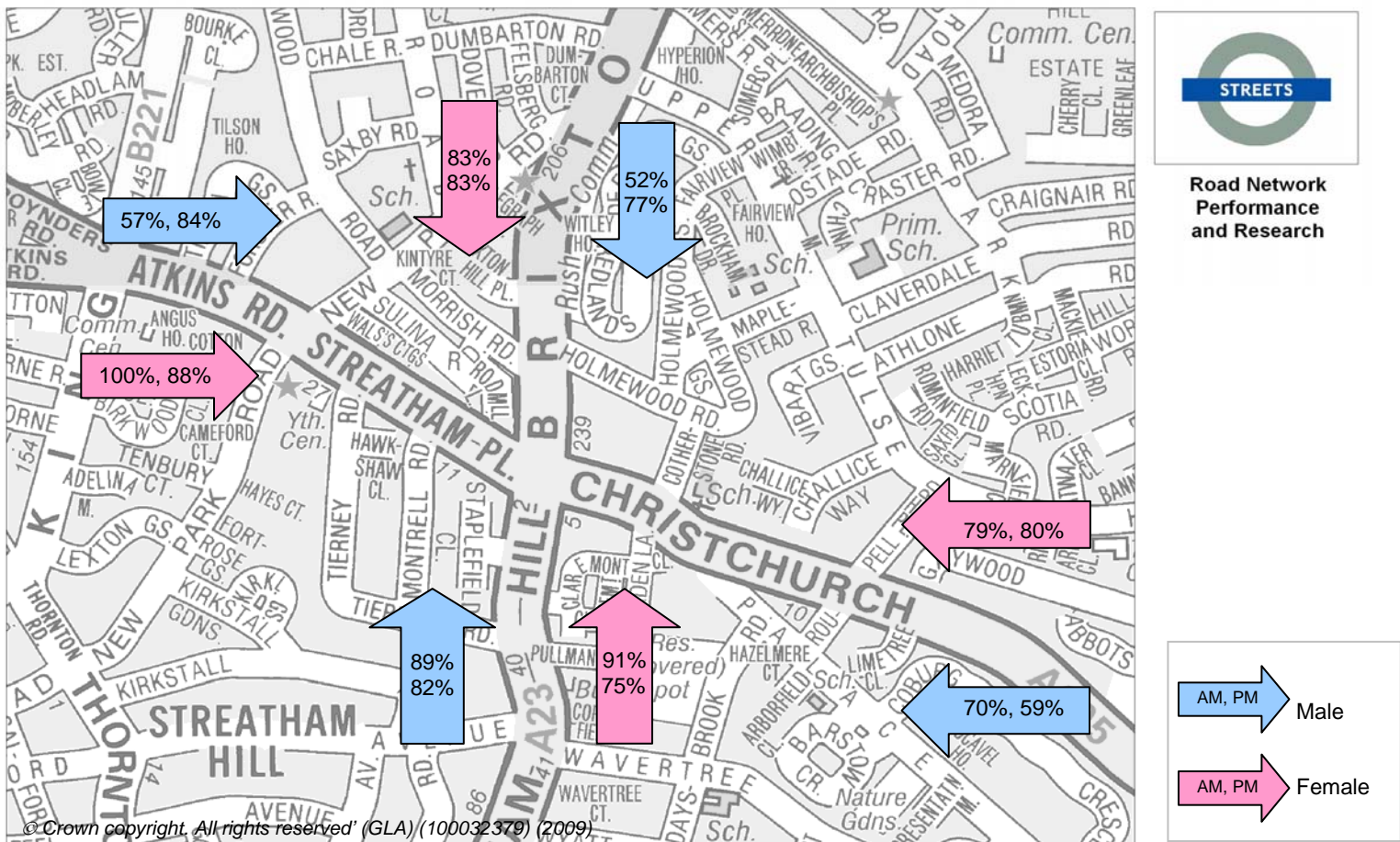
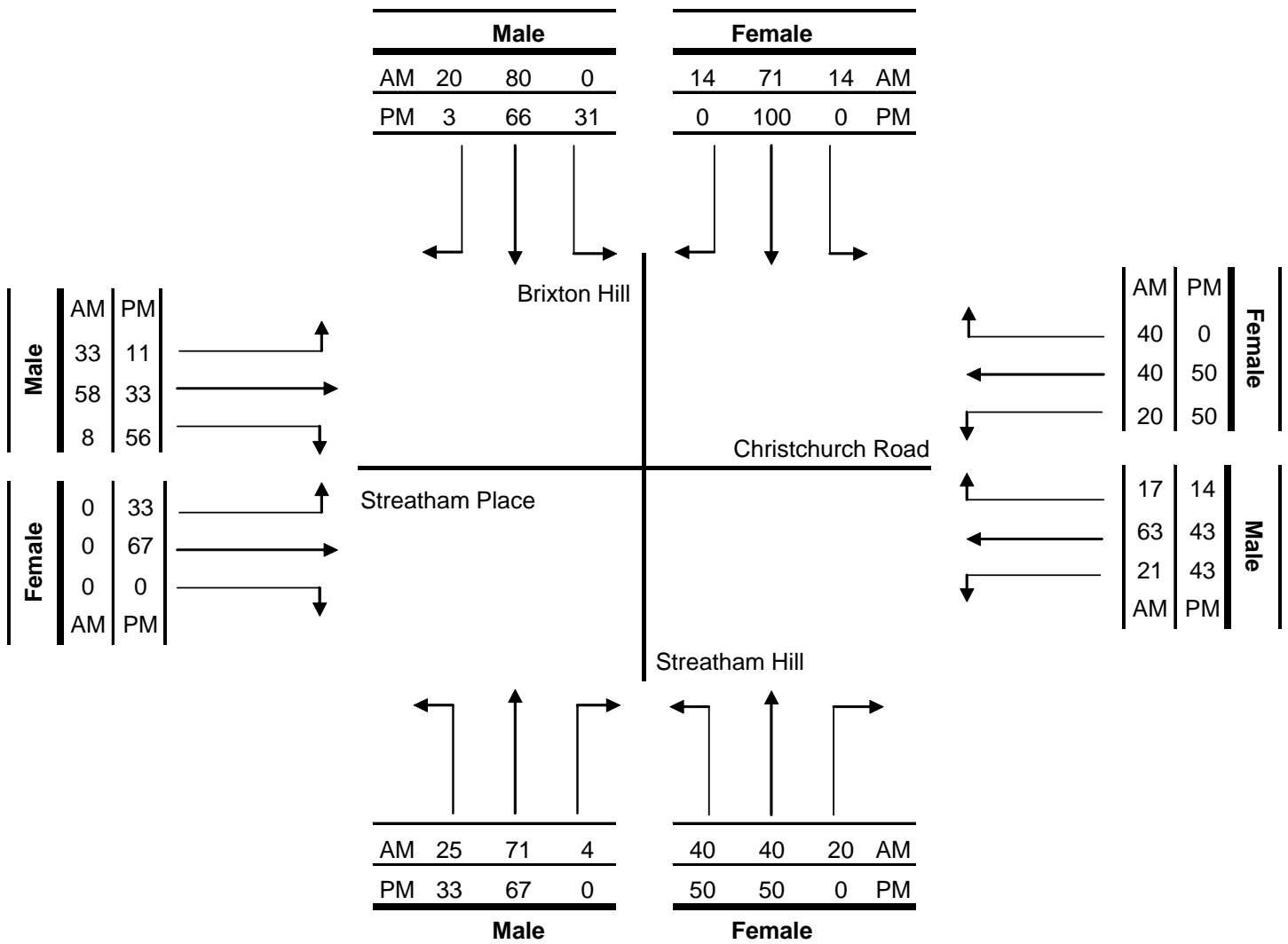

Figure 10 – Proportion of cyclists who **did not violate** red lights at Brixton Hill by time and gender



- 4.5 Figure 9 shows a comparison of the proportion of male and female cyclists that violated traffic lights on the day of the survey. In all but one instance a greater proportion of men than women did not obey the red light, supporting the evidence shown in Table 8.
- 4.6 Generally speaking, larger proportions of cyclists of both genders ran through red lights during the PM peak than the AM peak. The only time that more cyclists ran red lights in the AM peak were males on Arms A and D. In both instances cyclists were moving away from London, directly contrasting evidence found at site 2. This supports the hypothesis that red light jumping varies by time of day, and may reflect lower traffic levels at those particular arms and in those particular directions. Again the higher proportions are in the non-peak direction.
- 4.7 It is important to note that both cases involved nearly half of all male cyclists using each arm violating red lights. Although smaller numbers of cyclists were involved than on other arms these are large proportions.
- 4.8 Figure 10 shows a comparison of the proportion of male and female cyclists that obeyed the traffic lights during the surveyed hours. As expected it shows a direct contrast of Figure 9. All figures are high, especially in the AM peak. This is with the exception of male cyclists using arms A and D, where the figure is higher in the PM peak.

Figure 11 - Difference in the turning direction of red light violators



- 4.9 Figure 11 shows a breakdown of the turning direction of the cyclists that jumped red lights at site 3. In all but one instance the highest proportion of both male and female cyclists that rode through a red light travelled straight ahead at the junction. This was seen in both the morning and evening peaks. The only time this did not occur was in the evening peak on Streatham Place, where the majority of male cyclists turned right.

Other Issues

- 4.10 One surveyor noted that approximately 10% of cyclists using the junction rode on the pavement. Another said that of those cyclists using Streatham Hill, four rode on the pavement to avoid stopping at a red light.

5 Site 4 - Camberwell New Road

5.1 This section provides a summary and analysis of cyclists riding through red lights at site 4, as surveyed in May 2007. Table 10, below, shows the total number of cyclists that used each arm of Site 4 during the surveyed hours.

Table 10 – All cyclists using Camberwell Road during the morning and evening peaks

| | Total number of cyclists | | | | | | | |
|----------------|--------------------------|---------------|---------------|---------------|---------------|---------------|---------------|---------------|
| | Arm A | | Arm B | | Arm C | | Arm D | |
| | Non-Violation | Non-Violation | Non-Violation | Non-Violation | Non-Violation | Non-Violation | Non-Violation | Non-Violation |
| Total Cyclists | 80 | 230 | 39 | 417 | 161 | 441 | 95 | 362 |
| % Cyclists | 26 | 74 | 9 | 91 | 27 | 73 | 21 | 79 |

Please note that arms are as follows: Arm A – Camberwell Road; Arm B – Camberwell Church Street; Arm C – Denmark Hill; Arm D – Camberwell New Road

5.2 Table 10 shows that the majority of cyclists obeyed the red lights and did not run through them. Of the 1825 cyclists that used the junction during the surveyed hours an average of 79% of cyclists did not violate red lights. As such the anecdotal evidence that most cyclists ride through red lights cannot be attributed to this site.

Table 11 – Proportion of male and female cyclists who disobeyed red lights at Camberwell Road

| | Number of cyclists | | | | | |
|----------------|--------------------|---------------|-------|---------------|---------------|-------|
| | All Arms | | | | | |
| | Male | | | Female | | |
| | Non-Violation | Non-Violation | Total | Non-Violation | Non-Violation | Total |
| Total Cyclists | 306 | 1180 | 1486 | 69 | 270 | 339 |
| % Cyclists | 21 | 79 | 100 | 20 | 80 | 100 |

5.3 Table 11 shows that over four times as many male cyclists used the junction during the survey hours than female cyclists, with a total of 1486 and 339 respectively. The proportion of men and women that violated red lights is almost the same, with the vast majority of both genders obeying the traffic signals. As such, the hypothesis that men are more likely than women to rider through red lights cannot be applied to this junction when it is looked at as a whole. Table 12 shows the variations between each arm.

Table 12 – Comparison of cyclists that violated traffic signals at each arm of Camberwell Road

| Total number of cyclists during the AM and PM peaks | | | | | | | | |
|---|----------------|--------------|----------|--------------|----------|--------------|----------|--------------|
| | Arm A | | | | Arm B | | | |
| | Male | | Female | | Male | | Female | |
| | Violator | Non-Violator | Violator | Non-Violator | Violator | Non-Violator | Violator | Non-Violator |
| | Total Cyclists | 60 | 202 | 20 | 28 | 39 | 346 | 0 |

| | Arm C | | | | Arm D | | | |
|--|----------------|--------------|----------|--------------|----------|--------------|----------|--------------|
| | Male | | Female | | Male | | Female | |
| | Violator | Non-Violator | Violator | Non-Violator | Violator | Non-Violator | Violator | Non-Violator |
| | Total Cyclists | 137 | 349 | 24 | 92 | 70 | 283 | 25 |

Please note that arms are as follows: Arm A – Camberwell Road; Arm B – Camberwell Church Street; Arm C – Denmark Hill; Arm D – Camberwell New Road

- 5.4 Table 12 shows the total number of cyclists who either violated or respected red lights during both the AM and PM peaks. Whilst the majority of cyclists did obey the traffic signals at each arm, there are differences in the number of male and female cyclists that did so. Far more men than women jumped red lights at each arm although the proportion varies at each arm; in the case of Arm B, no women ran through the lights, whilst 39 men did. On each of the other arms at least three times as many men went through red lights than women. Further analysis can be found in Figure 12 and Figure 13 below.

Figure 12 - Proportion of cyclists who violated red lights at Camberwell Rd by time and gender

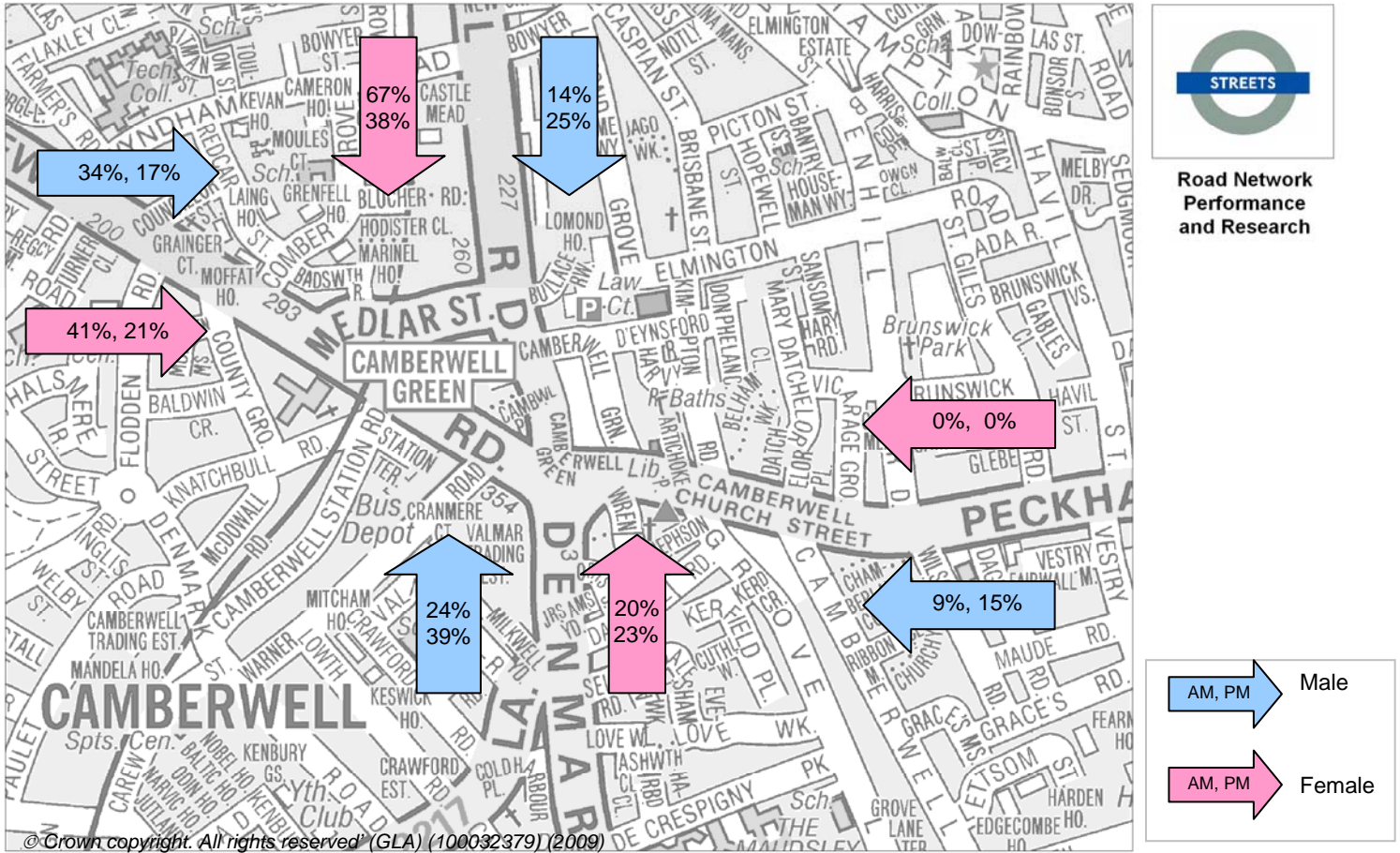
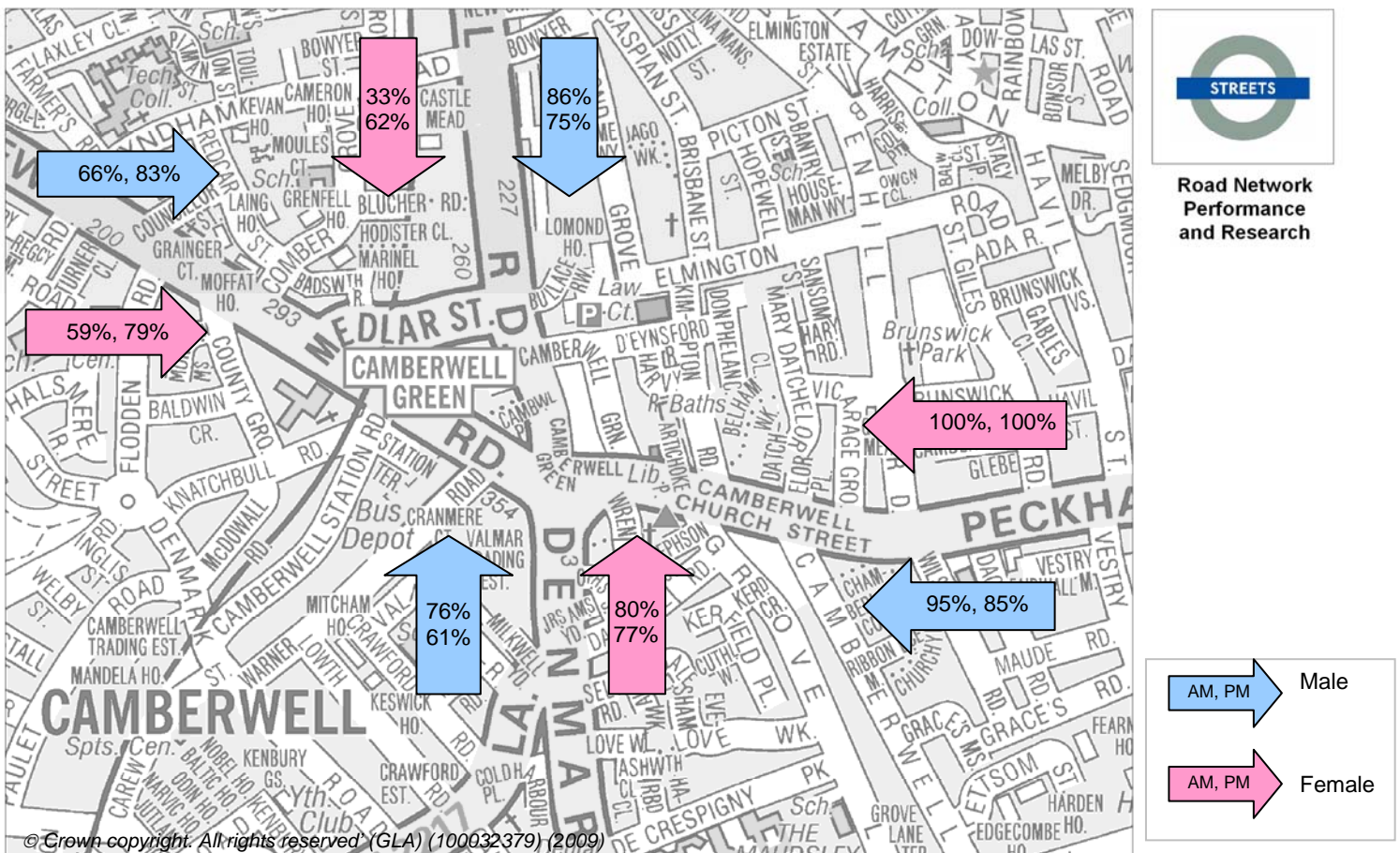
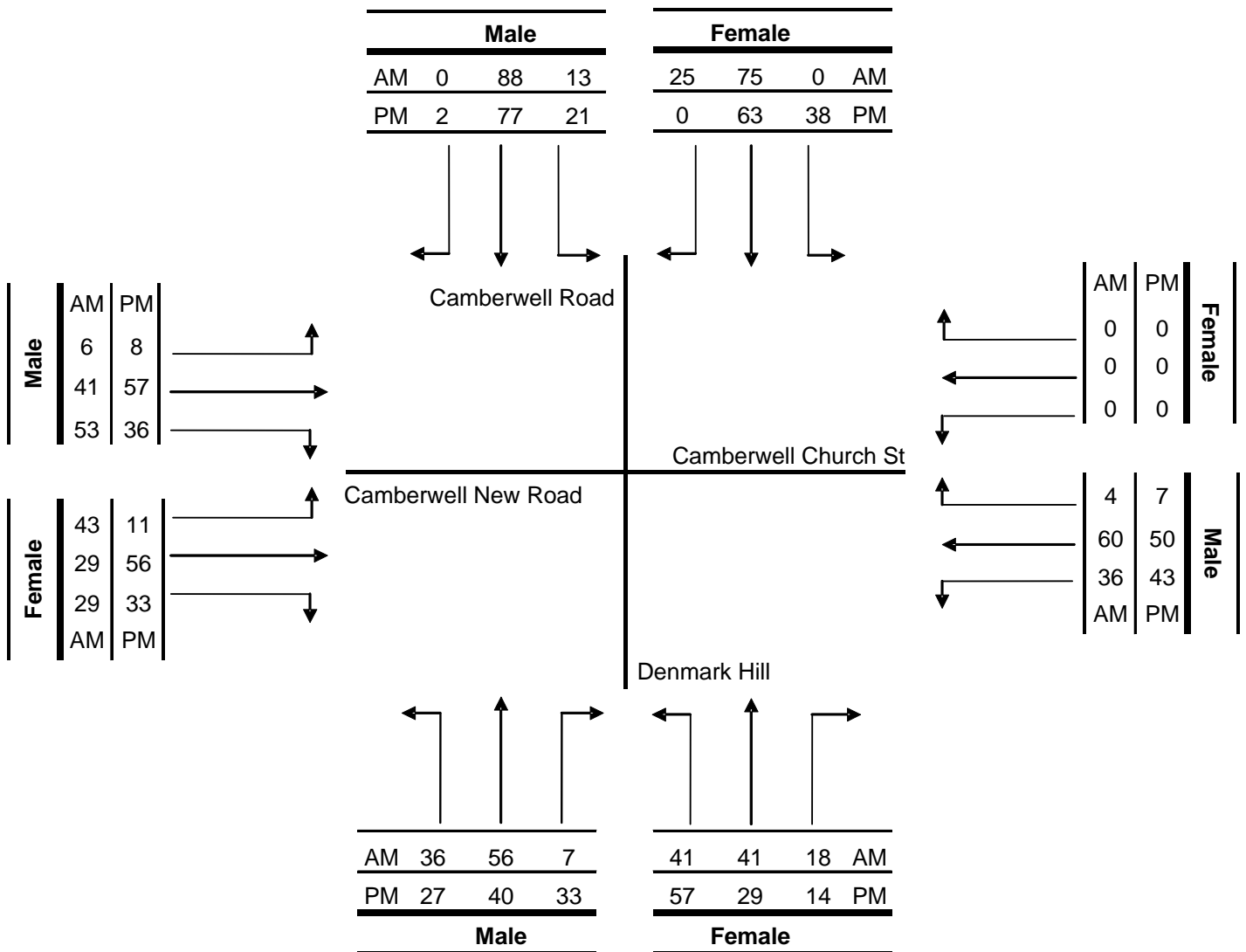

Figure 13 - Proportion of cyclists who did not violate red lights at Camberwell Rd by time and gender



- 5.5 Figure 15 shows a comparison of the proportion of male and female cyclists that violated traffic lights on the day of the survey. Unlike previously sites the difference in the proportion of men and women that did not obey red lights varies widely across the arms of the junction. A greater proportion of women jumped red lights on the two arms travelling away from London, however on Camberwell Road the numbers of females was low, 4 out of 6 cyclists violating the red light. This was true in both the morning and evening peaks. In contrast a greater proportion of men jumped red lights on the remaining two arms in both the morning and evening peaks. However, the differences in proportion were not as great as was seen at other surveyed sites.
- 5.6 Generally speaking, a higher proportion of cyclists of both genders ran through red lights during the PM peak than the AM peak. However a greater proportion of cyclists ran red lights in the AM peak on Arms A and D. In both instances cyclists counted were moving away from London, similar to evidence found at site 3. This supports the hypothesis that red light jumping varies by time of day, and may reflect lower traffic levels at those particular arms and in those particular non-peak directions.

Figure 14 - Difference in the turning direction of red light violators



- 5.7 Figure 14 shows a break down of the turning direction of the cyclists that jumped red lights at site 4. There is a marked difference on each arm in the turning movements of those cyclists that ran through red lights. For example, the majority of cyclists that jumped red lights on Camberwell Road and Camberwell Church Street travelled straight ahead at the junction.
- 5.8 There was a much larger variety of movements by cyclists jumping red lights on the remaining two arms of the junction. On Camberwell New Road the majority of female cyclists jumping red lights turned left in the morning, but rode straight ahead in the evening. Conversely, the majority of male cyclists jumping red lights on this arm turned right in the morning, and went straight ahead in the evening. A similar split was evident on the Denmark Hill arm of the junction, with most women turning left, and most men going straight ahead.
- 5.9 It is notable that no female cyclists jumped red lights at any time of day when approaching the site from Camberwell Church Street. However, 71 women did approach from that direction, choosing to obey the signals.

6 Site 5 - Greenwich South Street

6.1 This section provides a summary and analysis of cyclists riding through red lights at site 5, as surveyed in May 2007. Table 13, below, shows the total number of cyclists that used each arm of Site 5 during the surveyed hours.

Table 13 – All cyclists using Greenwich South Street during the morning and evening peaks

| | Total number of cyclists | | | | | | | |
|----------------|--------------------------|---------------|-----------|---------------|-----------|---------------|-----------|---------------|
| | Arm A | | Arm B | | Arm C | | Arm D | |
| | Violation | Non-Violation | Violation | Non-Violation | Violation | Non-Violation | Violation | Non-Violation |
| Total Cyclists | 8 | 71 | 5 | 52 | 14 | 81 | 20 | 60 |
| % Cyclists | 10 | 90 | 9 | 91 | 15 | 85 | 25 | 75 |

Please note that arms are as follows: Arm A – Greenwich South Street; Arm B – Blackheath Hill; Arm C – Lewisham Road; Arm D – Blackheath Road

6.2 Table 13 shows that the majority of cyclists obeyed the red lights and did not run through them. Of the 311 cyclists that used the junction during the surveyed hours an average of 85% of cyclists did not violate red lights. As such the anecdotal evidence that most cyclists ride through red lights cannot be attributed to this site.

Table 14 – Proportion of male and female cyclists who disobeyed red lights at Greenwich South St

| | Number of cyclists | | | | | |
|----------------|--------------------|---------------|-------|-----------|---------------|-------|
| | All Arms | | | | | |
| | Male | | | Female | | |
| | Violation | Non-Violation | Total | Violation | Non-Violation | Total |
| Total Cyclists | 36 | 239 | 275 | 11 | 25 | 36 |
| % Cyclists | 13 | 87 | 100 | 31 | 69 | 100 |

6.3 Table 14 shows that nearly eight times as many male cyclists used the junction during the surveyed hours than female cyclists, with a total of 275 and 36 cyclists respectively. There is a large difference between the proportion of men and women that violated red lights. Unlike previous sites, more women disobeyed traffic signals, with 31% riding through red lights. In contrast just 13% of men did so. However, as only 36 female cyclists used the junction during the surveyed hours, this may not be a representative sample. Table 15 show the variations between each arm

Table 15 – Number of cyclists that violated each arm at Greenwich South Street

| Total number of cyclists during the AM and PM peaks | | | | | | | | |
|---|----------|--------------|----------|--------------|----------|--------------|----------|--------------|
| | Arm A | | | | Arm B | | | |
| | Male | | Female | | Male | | Female | |
| | Violator | Non-Violator | Violator | Non-Violator | Violator | Non-Violator | Violator | Non-Violator |
| Total Cyclists | 7 | 61 | 1 | 10 | 5 | 46 | 0 | 6 |

| | Arm C | | | | Arm D | | | |
|----------------|----------|--------------|----------|--------------|----------|--------------|----------|--------------|
| | Male | | Female | | Male | | Female | |
| | Violator | Non-Violator | Violator | Non-Violator | Violator | Non-Violator | Violator | Non-Violator |
| Total Cyclists | 10 | 74 | 4 | 7 | 14 | 58 | 6 | 2 |

6.4 Table 15 shows the total number of cyclists who either violated or respected red lights during both the AM and PM peaks. Although the majority of cyclists did obey the traffic signals at each arm it is difficult to compare the total number of men and women that did so, as so few female cyclists used the junction during the surveyed hours. As a result the remainder of this section will examine the behaviour of male cyclists at this junction only.

Figure 15 – Proportion of male cyclists who violated or did not violate red lights at Greenwich South Street by time of day

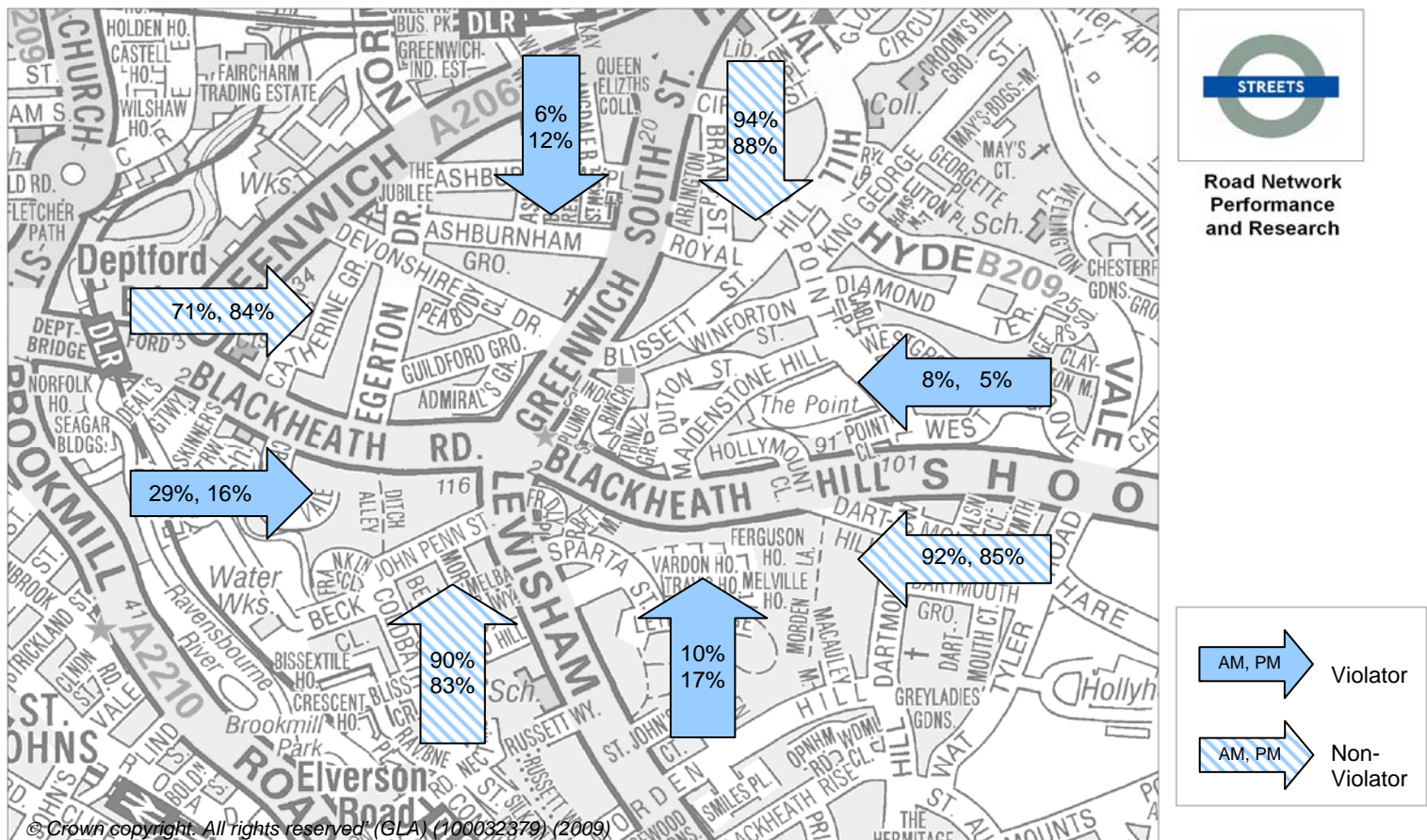

6.5 Figure 15 shows a comparison of proportions of male cyclists that either violated or did not violate traffic lights on the day of the survey. On arms B and D more cyclists ran red lights in the AM peak, whilst more did so in the PM peak on arms A and C. This supports the hypothesis that red light jumping varies by time of day, and may reflect lower traffic levels in those particular arms at that time of day.

Figure 16 – Difference in the turning direction of male red light violators

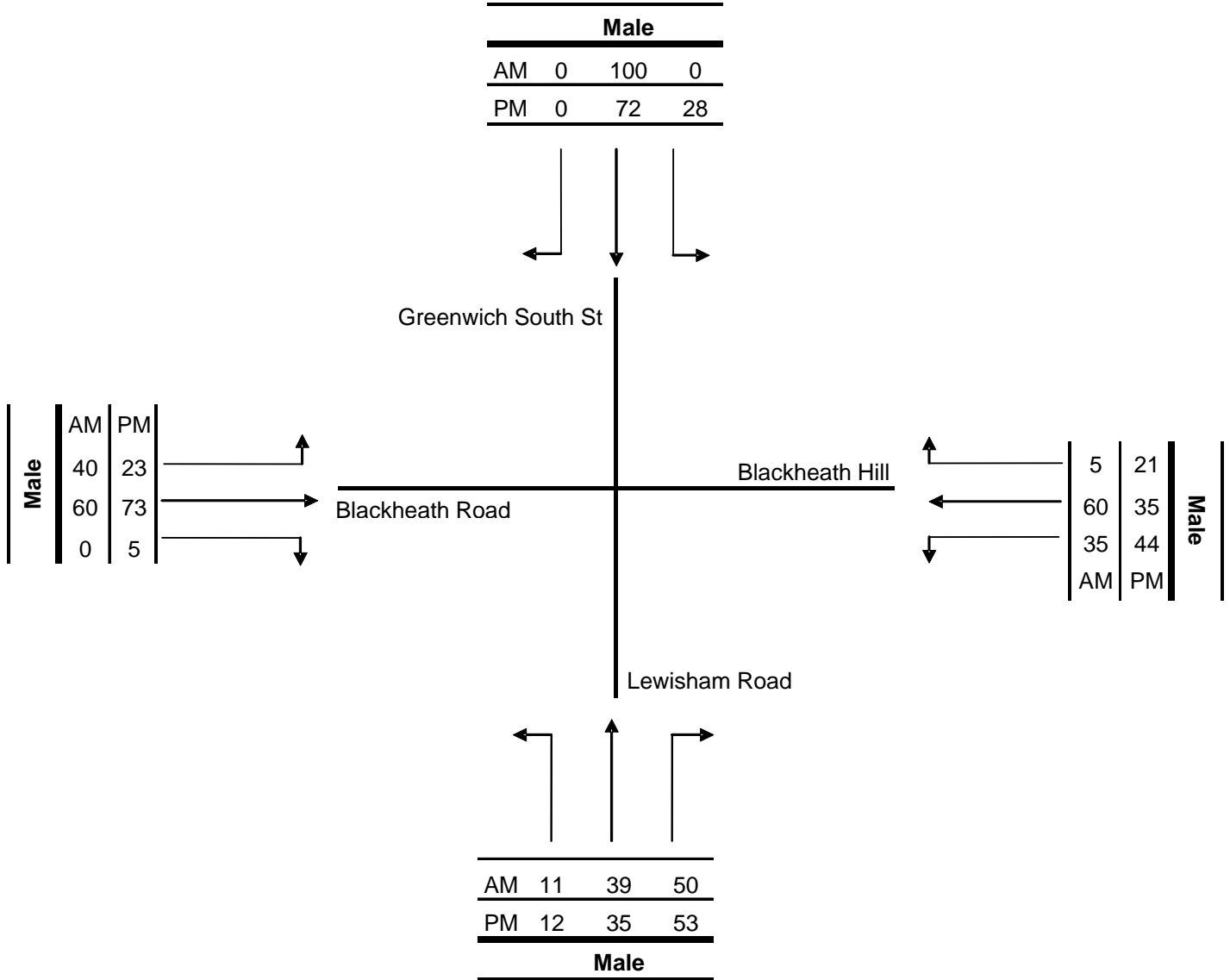

6.6 Figure 16 shows a comparison of the turning direction of the male cyclists who ran through red lights at site 5. On all but one arm, (Lewisham Road), the majority of red light jumpers went straight ahead over the junction. On Lewisham Road however, most cyclists who violated the traffic signals did so whilst turning right. This was true of both the morning and evening peaks. It is notable that very few, if any, cyclists ran through the red light whilst turning right on the any of the other arms of the junction.

Other Issues

6.7 One surveyor (on Blackheath Road) noted that this is a very dangerous junction which possibly explains why far fewer cyclists use this junction than any of the previous sites.

7 Summary

- 7.1 Cycling levels in London have risen dramatically since 2002. Recently anecdotal evidence has emerged which suggests that the majority of cyclists disobey the law and cycle through red lights. Articles have also emerged in the press recently, stating that women are more likely to obey the law and wait at traffic lights. It is claimed that this has led to increased numbers of deaths of female cyclists. The validity of these claims has been examined in this report and is summarised below.
- 7.2 The evidence from this small survey shows that it is very hard to make overall generalisations. Observance of red lights at junction varies from site to site, different arms within a site, by time of day and the gender of the cyclist.

Table 16 – Summary of the proportion of cyclist violations at each site

| | Total number of cyclists | | | | | |
|----------------|--------------------------|---------------|-----------|---------------|-----------|---------------|
| | Site 1 | | Site 2 | | Site 3 | |
| | Violation | Non-Violation | Violation | Non-Violation | Violation | Non-Violation |
| Total Cyclists | 458 | 3054 | 133 | 879 | 167 | 675 |
| % Cyclists | 13 | 87 | 13 | 87 | 20 | 80 |
| | Site 4 | | Site 5 | | AVERAGE | |
| | Violation | Non-Violation | Violation | Non-Violation | Violation | Non-Violation |
| | Total Cyclists | 375 | 1450 | 47 | 264 | 1180 |
| % Cyclists | 21 | 79 | 15 | 85 | 16 | 84 |

- 7.3 Table 16, above, summarises the number and proportion of cyclists who violated red lights at each site. A total of 7502 cyclists were surveyed across all of the sites. Of these, an average of 16% violated red lights, whilst the remaining 84% obeyed the traffic signals. Therefore it can be concluded that the majority of cyclists **do not** ride through red lights. However, the 16% that do must be discouraged from ignoring traffic signals.

Table 17 – Summary of the proportion of male and female cyclists that violated red lights

| | Number of cyclists | | | | | |
|----------------|--------------------|---------------|-------|-----------|---------------|-------|
| | All Arms | | | | | |
| | Male | | | Female | | |
| | Violation | Non-Violation | Total | Violation | Non-Violation | Total |
| Total Cyclists | 961 | 4860 | 5821 | 219 | 1462 | 1681 |
| % Cyclists | 17 | 83 | 100 | 13 | 87 | 100 |

- 7.4 Table 17 summarises the total number of cyclists and proportion of men and women, and shows that nearly three and a half times more male cyclists used the surveyed junctions than female cyclists, 78% male to 22% female. Whilst it is not known if this is representative of the whole of London, it indicates that a large majority of cyclists are male.
- 7.5 Table 17 also shows that the proportion of men that ride through red lights is slightly higher than the proportion of women. 17% of male cyclists chose to disobey traffic signals when evidence from all sites was combined, whilst just 13% of female cyclists did. This supports the hypothesis that men are more likely to cycle through red lights than women to some extent, and also supports reports in the press that more women wait for a green light.

Table 18 – Proportion of turning movements by male and female red light violators

| | | Proportion of turning movements red light violators made | | | | | |
|------------|---------|--|-------|-------|--------|-------|-------|
| | | Number of cyclists | | | | | |
| | | All Arms | | | | | |
| | | Male | | | Female | | |
| | | Left | Ahead | Right | Left | Ahead | Right |
| % Cyclists | Site 1 | 29 | 55 | 17 | 14 | 62 | 24 |
| | Site 2 | 20 | 56 | 23 | 50 | 48 | 3 |
| | Site 3 | 25 | 60 | 15 | 30 | 60 | 11 |
| | Site 4 | 24 | 59 | 18 | 32 | 49 | 20 |
| | Site 5 | 24 | 59 | 17 | NA | NA | NA |
| | AVERAGE | 24 | 58 | 18 | 31 | 55 | 14 |

Please note: Data for female cyclists using Site 5 has not been included as relatively few used it. As such the evidence was deemed insufficiently robust

- 7.6 Table 18 shows the proportion of turning movements that the cyclists who violated red lights made. On average, the majority of both male and female cyclists went straight ahead at the junction following violating a red light. This was also true of male cyclists at individual junctions. However there was a 45:55 split between female cyclists turning and going straight ahead.
- 7.7 Table 18 also demonstrates that as expected, a much smaller proportion of cyclists violated red lights whilst turning right at a junction. This is probably due to the increased danger in performing such a move.

- 7.8 This report did not investigate whether the red phase at each junction included a pedestrian movement. This is a topic for further investigation.
- 7.9 The following general conclusions can be made based on the evidence described above:
- The majority of cyclists (84%) obey red traffic lights.
 - Violation is not endemic, but 1 in 6 (16%) of cyclists do jump a red light, and at this level may encourage more to do so in the future.
 - A much greater number of men cycle during the morning and evening peaks. When a comparison is made of the behaviour of male and female cyclists it can be concluded that men are slightly more likely to violate red lights (17% compared to 13%).
 - In general cyclists who ride through red lights are more likely to do so whilst travelling straight ahead at a junction. They are least likely to do so when turning right.
 - Red light violations are most common by cyclists travelling towards central London in the morning, and away from central London in the evening.

8 Library of technical notes

Other technical notes in the RNPR series include:

Technical notes

- ITIS – Validation Paper July 2005
- RNPR Technical Note 1 – ITIS Speed Survey Data
- RNPR Technical Note 2 – Traffic Delays in London on Weekdays, Saturdays and Sundays
- RNPR Technical Note 3 – Total vehicle delay for London
- RNPR Technical Note 4 - Validation of radar traffic monitoring equipment (published as an internal working document)
- RNPR Technical Note 6 - Validation of automatic traffic & cycle counters 2006 (published as an internal working document)

Traffic Notes

DfT NRTCC Counts

- RNPR Traffic Note 1 – Traffic levels on major roads in Greater London 1993-2007 (Published November 2008. Update with 2008 flows due in Autumn 2009)

TfL Automatic Traffic Counts

- RNPR Traffic Note 2 - Expansion factors for road traffic counts in London

TfL Cordon and Screenline Counts

- RNPR Traffic Note 3 – TfL Cordon and Screenlines 1975 to 2007 (2008 update due Spring 2009)
- RNPR Traffic Note 5 - Major and Minor traffic flows measured through TfL Cordon surveys

ITIS and Moving Observer Survey Data

- RNPR Traffic Note 4 – Traffic Speed in London 2003-2007 (Draft in preparation – publication date TBC)
- RNPR Traffic Note 6 – Traffic delays in the London Boroughs 2007 (published on LondonStreetWorks website)

Cycling

- RNPR Traffic Note 7 - Weather conditions and the levels of cycling on the TLRN
- RNPR Traffic Note 8 – Proportion of cyclists violating red lights
- RNPR Traffic Note 9 – Cycling trends in London (due to be published in early 2009)
- RNPR Traffic Note 10 – TfL Pedestrian and Cycle Thames Screenline Surveys 2006-2007 (due to be published in early 2009)
- RNPR Traffic Note 11 – Cycling journey time reliability (due to be published in early 2009)

Other useful documents

- London Travel Report 2007 –
<http://www.tfl.gov.uk/assets/downloads/corporate/London-Travel-Report-2007-final.pdf>
- Transport Statistics for Great Britain 2007 -
http://www.dft.gov.uk/162259/162469/221412/217792/2214291/TSGB2007Final_linksV12.pdf

9 Contacts for further information

- 9.1 If you require further information on this traffic note or have any other related queries please contact:

Mike Tarrier
0203 054 0891
mike.tarrier@tfl.gov.uk

Lee Abbott
0203 054 0894
lee.abbott@tfl.gov.uk

Hannah Batchelor
0203 054 0898
hannah.batchelor@tfl.gov.uk

Martin Obee
0203 054 0893
martin.obee@tfl.gov.uk

Parvin Miah
0203 054 0897
parvin.miah@tfl.gov.uk