

Transport and Works Act 1992

London Underground (Northern Line Extension) Order

Deposited plans and sections



Transport and Works Act 1992
London Underground (Northern Line Extension) Order

DEPOSITED PLANS AND SECTIONS

Transport for London
Windsor House
Victoria Street
London
SW1H 0TL

Halcrow Group Ltd
A CH2M Hill Company
Elms House
43 Brook Green
London W6 7EF

Bircham Dyson Bell LLP
50 Broadway
London
SW1H 0BL

Ardent Management Limited
Level 33
25 Canada Square
London
E14 5LQ

Transport and Works Act 1992 London Underground (Northern Line Extension) Order Deposited Plans and Sections

Index

Location and Key Plan
Plans
Sections

Sheets 1 -7
Sheets 8 - 19

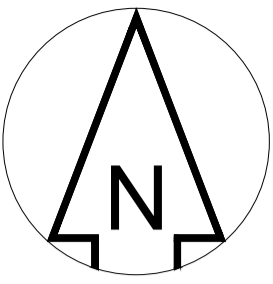

Transport and Works Act 1992
London Underground (Northern Line Extension) Order
LONDON BOROUGHS OF WANDSWORTH, LAMBETH AND SOUTHWARK
Location and Key Plan

KEY



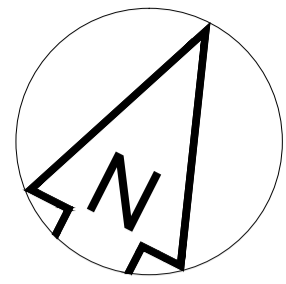

Transport and Works Act 1992

London Underground (Northern Line Extension) Order

LONDON BOROUGH OF WANDSWORTH

KEY

- XXXXX PARCEL NUMBER
- LIMITS OF DEVIATION AND OF LAND TO BE ACQUIRED AND USED (SUBSOIL ONLY) AND LIMITS OF LAND TO BE USED TEMPORARILY
- LIMITS OF DEVIATION AND OF LAND TO BE ACQUIRED AND USED (SUBSOIL ONLY)
- LIMITS OF DEVIATION AND OF LAND TO BE ACQUIRED AND USED
- LIMITS OF LAND TO BE USED ONLY TEMPORARILY
- LIMITS OF LAND FOR PROTECTIVE WORKS
- COMMENCEMENT OF SCHEDULED WORK
- TERMINATION OF SCHEDULED WORK
- A** ACCESS TO WORKS
- CENTRE LINE(S) OF SCHEDULED WORKS
- BOROUGH BOUNDARY

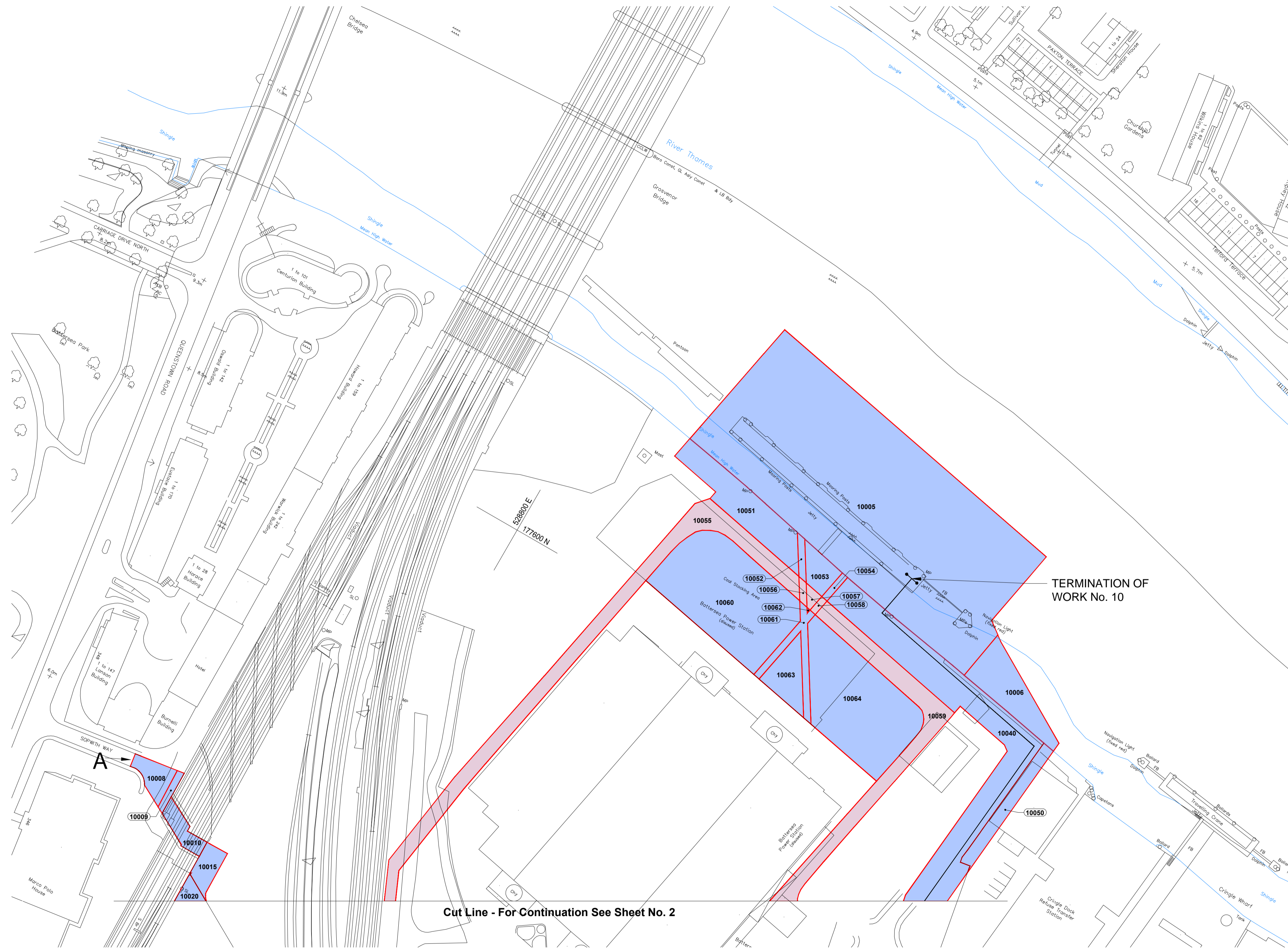

Based on Ordnance Survey Digital Data with the permission of H.M.S.O.
© Crown Copyright and database rights Ordnance Survey 100035791 / 035

PLAN

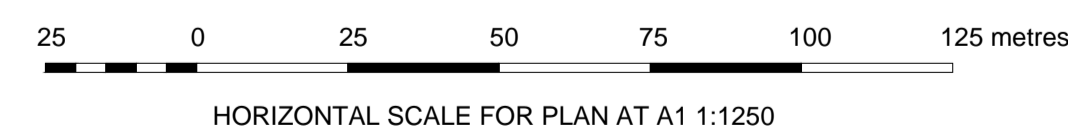

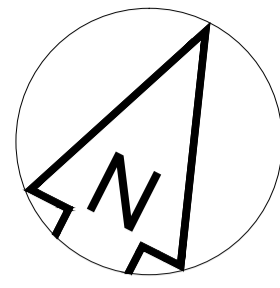

Transport and Works Act 1992

London Underground (Northern Line Extension) Order

LONDON BOROUGH OF WANDSWORTH

Work No. 3 (part), Work No. 9 and Work No. 10 (part)
 For Section of Work No. 3 see Sheet Nos. 8, 9 and 10
 For Section of Work No. 9 see Sheet No. 18
 For Section of Work No. 10 see Sheet No. 19

KEY

- PARCEL NUMBER
- LIMITS OF DEVIATION AND OF LAND TO BE ACQUIRED AND USED (SUBSOIL ONLY) AND LIMITS OF LAND TO BE USED TEMPORARILY
- LIMITS OF DEVIATION AND OF LAND TO BE ACQUIRED AND USED (SUBSOIL ONLY)
- LIMITS OF DEVIATION AND OF LAND TO BE ACQUIRED AND USED
- LIMITS OF LAND TO BE USED ONLY TEMPORARILY
- LIMITS OF LAND FOR PROTECTIVE WORKS
- COMMENCEMENT OF SCHEDULED WORK
- TERMINATION OF SCHEDULED WORK
- A ACCESS TO WORKS
- CENTRE LINE(S) OF SCHEDULED WORKS
- BOROUGH BOUNDARY

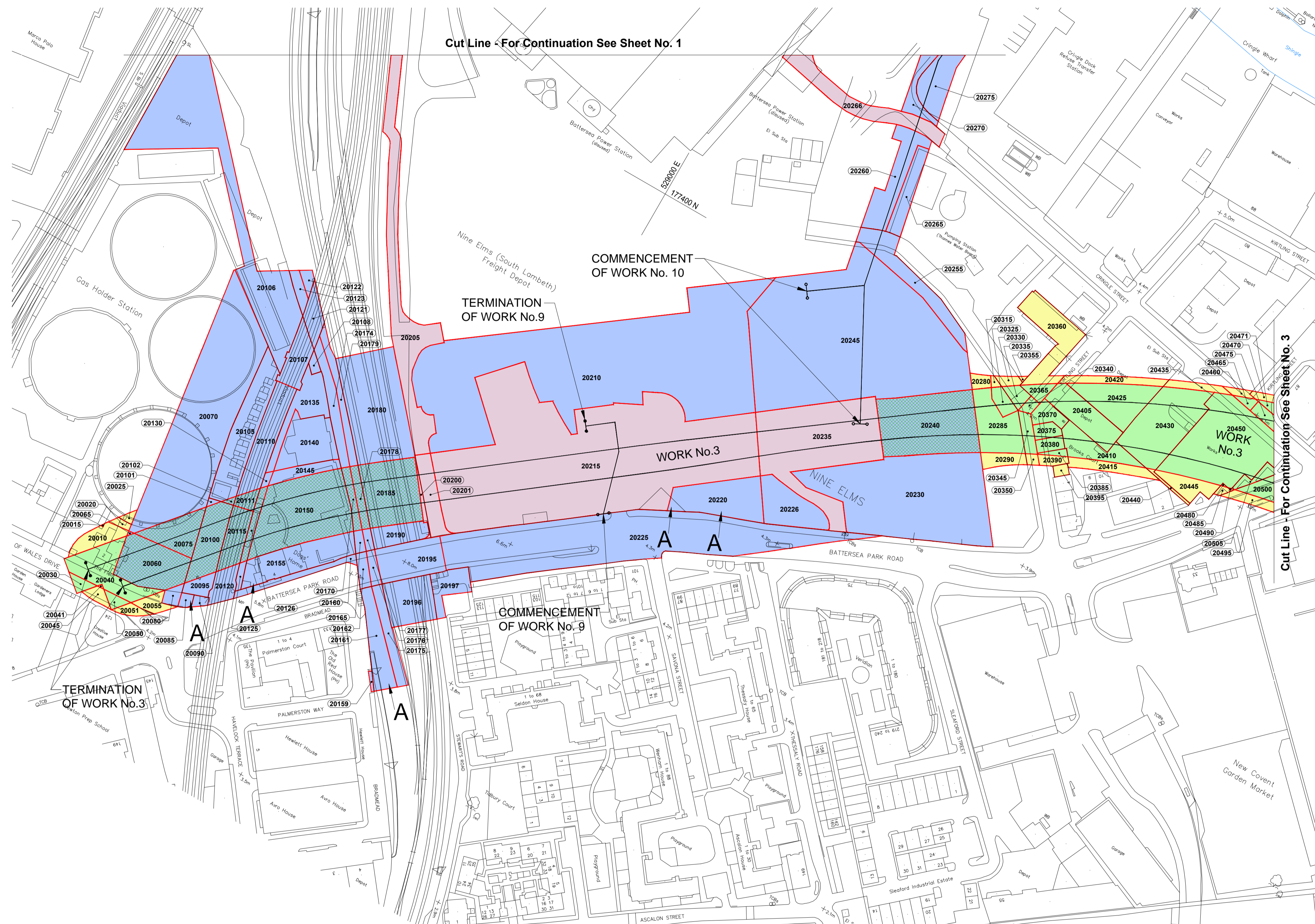

Based on Ordnance Survey Digital Data with the permission of H.M.S.O.
 © Crown Copyright and database rights Ordnance Survey 100035791 / 035

PLAN

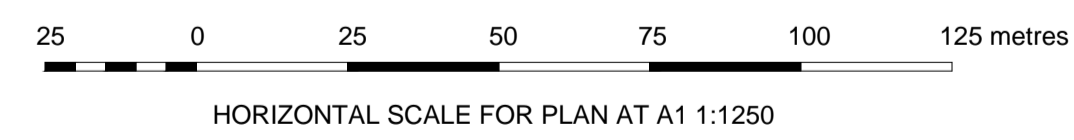

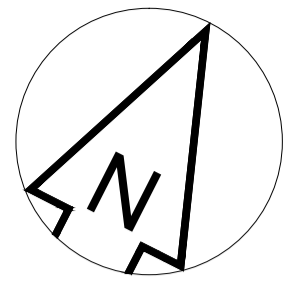

Transport and Works Act 1992

London Underground (Northern Line Extension) Order

LONDON BOROUGHS OF WANDSWORTH AND LAMBETH

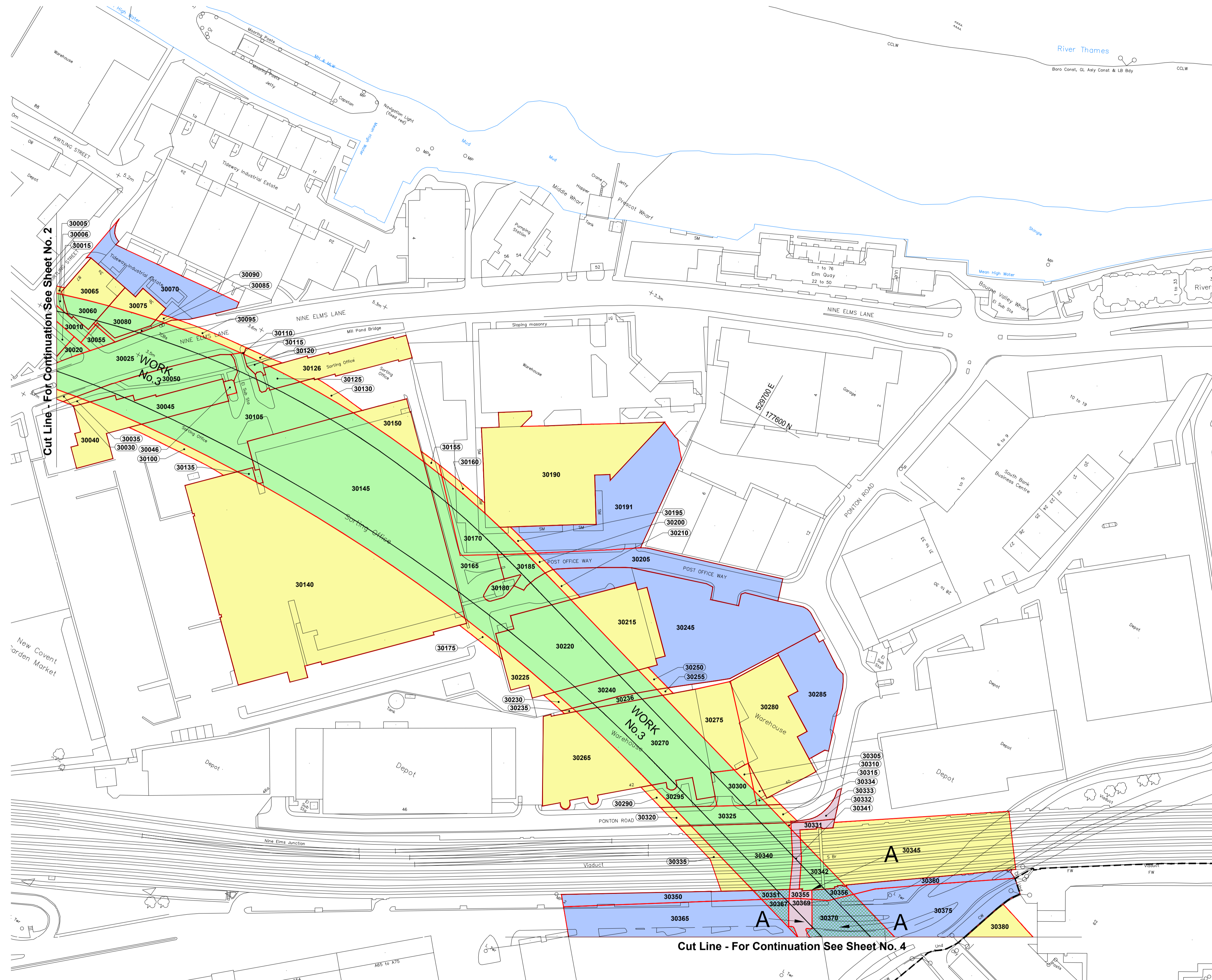

KEY

- XXXXX PARCEL NUMBER
- LIMITS OF DEVIATION AND OF LAND TO BE ACQUIRED AND USED (SUBSOIL ONLY) AND LIMITS OF LAND TO BE USED TEMPORARILY
- LIMITS OF DEVIATION AND OF LAND TO BE ACQUIRED AND USED (SUBSOIL ONLY)
- LIMITS OF DEVIATION AND OF LAND TO BE ACQUIRED AND USED
- LIMITS OF LAND TO BE USED ONLY TEMPORARILY
- LIMITS OF LAND FOR PROTECTIVE WORKS
- COMMENCEMENT OF SCHEDULED WORK
- TERMINATION OF SCHEDULED WORK
- A** ACCESS TO WORKS
- CENTRE LINE(S) OF SCHEDULED WORKS
- BOROUGH BOUNDARY

Based on Ordnance Survey Digital Data with the permission of H.M.S.O.
© Crown Copyright and database rights Ordnance Survey 100035791 / 035

PLAN

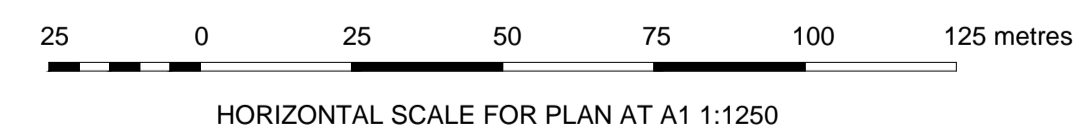

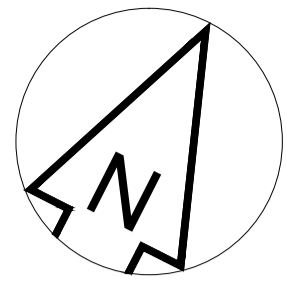

Transport and Works Act 1992 London Underground (Northern Line Extension) Order LONDON BOROUGHS OF WANDSWORTH AND LAMBETH

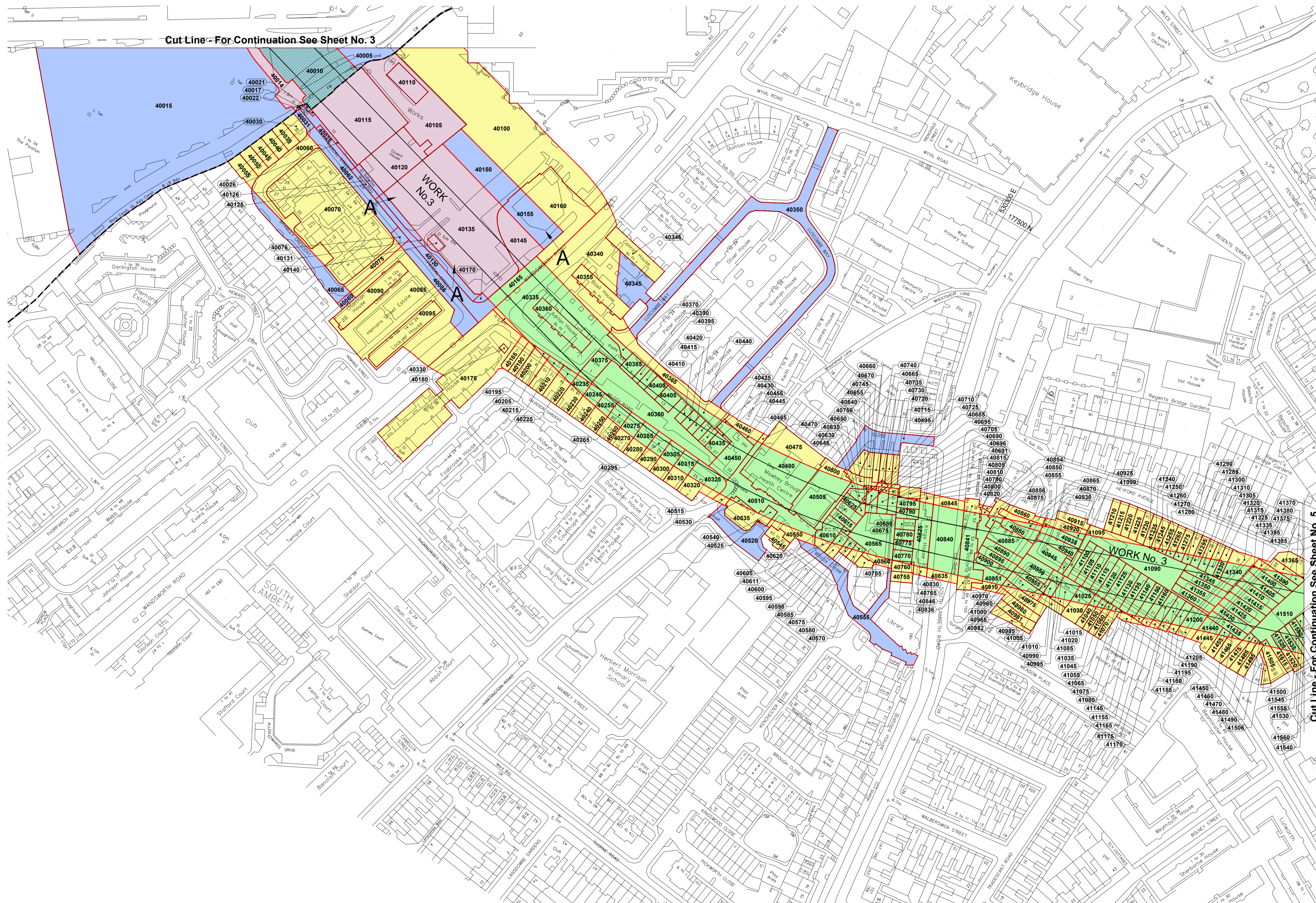

KEY

- XXXXX PARCEL NUMBER
- LIMITS OF DEVIATION AND OF LAND TO BE ACQUIRED AND USED (SUBSOIL ONLY) AND LIMITS OF LAND TO BE USED TEMPORARILY
- LIMITS OF DEVIATION AND OF LAND TO BE ACQUIRED AND USED (SUBSOIL ONLY)
- LIMITS OF DEVIATION AND OF LAND TO BE ACQUIRED AND USED
- LIMITS OF LAND TO BE USED ONLY TEMPORARILY
- LIMITS OF LAND FOR PROTECTIVE WORKS
- COMMENCEMENT OF SCHEDULED WORK
- TERMINATION OF SCHEDULED WORK
- A** ACCESS TO WORKS
- CENTRE LINE(S) OF SCHEDULED WORKS
- BOROUGH BOUNDARY

Based on Ordnance Survey Digital Data with the permission of H.M.S.O.
© Crown Copyright and database rights Ordnance Survey 100035791 / 035

PLAN

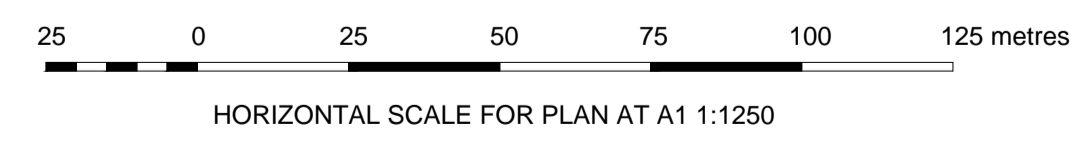

Cut Line - For Continuation See Sheet No. 5

Cut Line - For Continuation See Sheet No. 3

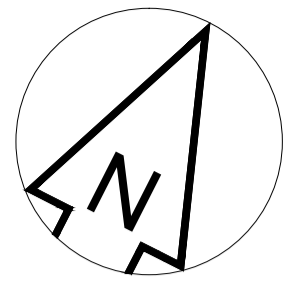

Transport and Works Act 1992 London Underground (Northern Line Extension) Order LONDON BOROUGH OF LAMBETH

Work No. 1 (part), Work No. 2 (part) and Work No. 3 (part)
For Section of Work No. 1 see Sheet No. 11
For Section of Work No. 2 see Sheet No. 12
For Section of Work No. 3 see Sheet Nos. 8, 9 and 10

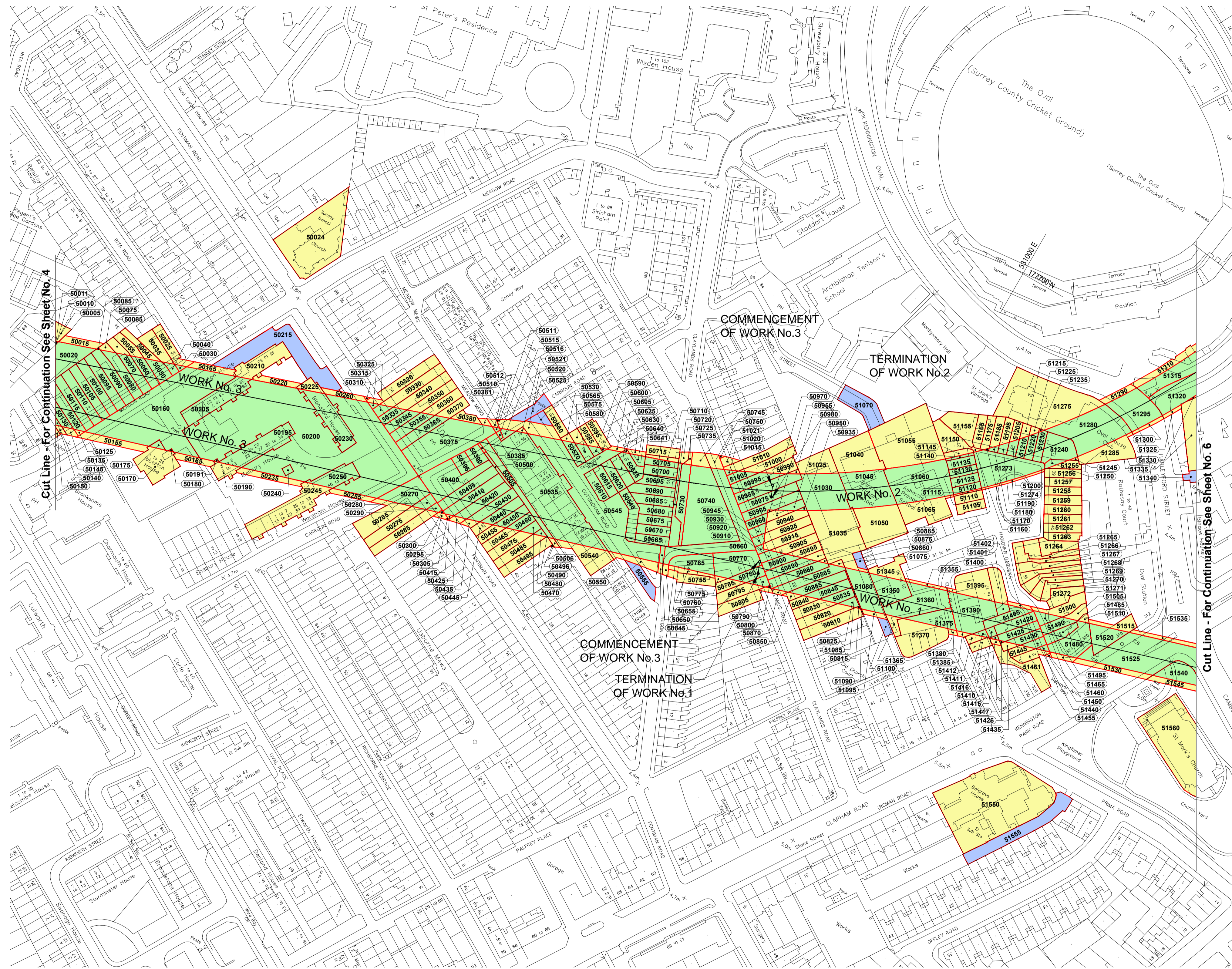

KEY

- XXXXX PARCEL NUMBER
- LIMITS OF DEVIATION AND OF LAND TO BE ACQUIRED AND USED (SUBSOIL ONLY) AND LIMITS OF LAND TO BE USED TEMPORARILY
- LIMITS OF DEVIATION AND OF LAND TO BE ACQUIRED AND USED (SUBSOIL ONLY)
- LIMITS OF DEVIATION AND OF LAND TO BE ACQUIRED AND USED
- LIMITS OF LAND TO BE USED ONLY TEMPORARILY
- LIMITS OF LAND FOR PROTECTIVE WORKS
- COMMENCEMENT OF SCHEDULED WORK
- TERMINATION OF SCHEDULED WORK
- A** ACCESS TO WORKS
- CENTRE LINE(S) OF SCHEDULED WORKS
- - - - - BOROUGH BOUNDARY

Based on Ordnance Survey Digital Data with the permission of H.M.S.O.
© Crown Copyright and database rights Ordnance Survey 100035791 / 035

PLAN

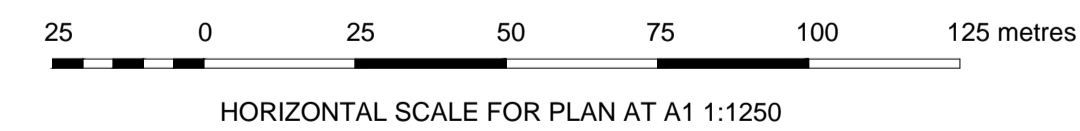

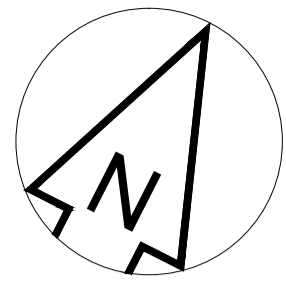

Transport and Works Act 1992 London Underground (Northern Line Extension) Order LONDON BOROUGHS OF LAMBETH AND SOUTHWARK

Work No. 1 (part), Work No. 2 (part), Work No. 5,
Work No. 6, Work No. 7 and Work No. 8
For Section of Work No. 1 see Sheet No. 11
For Section of Work No. 2 see Sheet No. 12
For Section of Work No. 5 see Sheet No. 17
For Section of Work No. 6 see Sheet No. 17
For Section of Work No. 7 see Sheet No. 16
For Section of Work No. 8 see Sheet No. 16

KEY

- xxxxx PARCEL NUMBER
- LIMITS OF DEVIATION AND OF LAND TO BE ACQUIRED AND USED (SUBSOIL ONLY) AND LIMITS OF LAND TO BE USED TEMPORARILY
- LIMITS OF DEVIATION AND OF LAND TO BE ACQUIRED AND USED (SUBSOIL ONLY)
- LIMITS OF DEVIATION AND OF LAND TO BE ACQUIRED AND USED
- LIMITS OF LAND TO BE USED ONLY TEMPORARILY
- LIMITS OF LAND FOR PROTECTIVE WORKS
- COMMENCEMENT OF SCHEDULED WORK
- TERMINATION OF SCHEDULED WORK
- A** ACCESS TO WORKS
- CENTRE LINE(S) OF SCHEDULED WORKS
- BOROUGH BOUNDARY

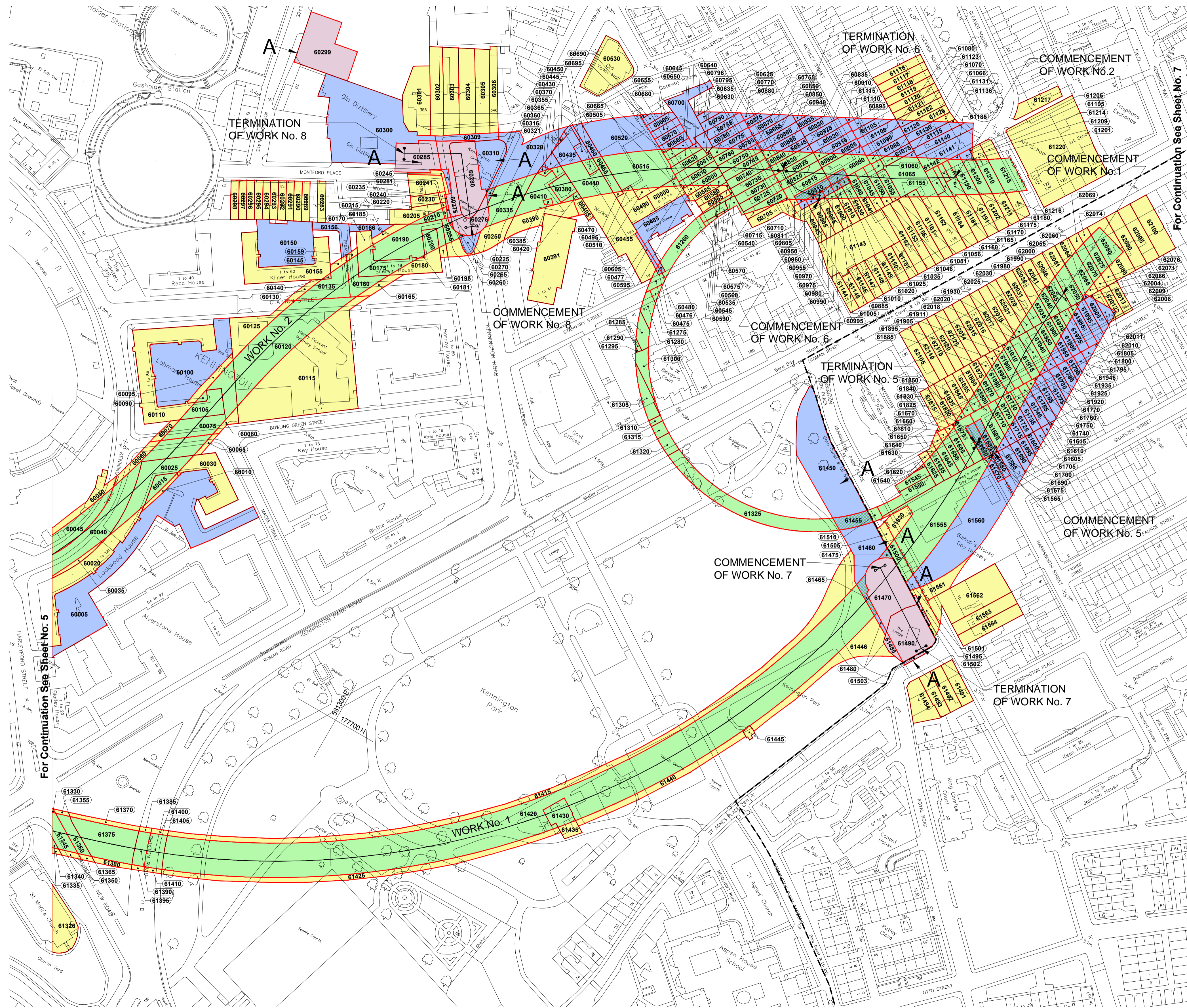

Based on Ordnance Survey Digital Data with the permission of H.M.S.O.
© Crown Copyright and database rights Ordnance Survey 100035791 / 035

PLAN

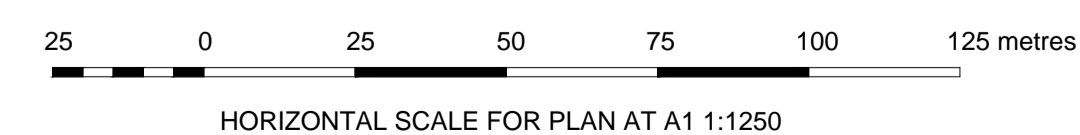

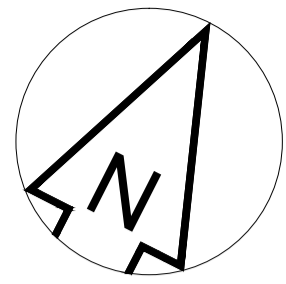

Transport and Works Act 1992 London Underground (Northern Line Extension) Order LONDON BOROUGHS OF LAMBETH AND SOUTHWARK

Work No. 4a, Work No. 4b, Work No. 4c and Work No. 4d
For Sections of Work Nos. 4a, 4b, 4c and 4d see Sheet No. 18



KEY

- XXXXX PARCEL NUMBER
- LIMITS OF DEVIATION AND OF LAND TO BE ACQUIRED AND USED (SUBSOIL ONLY) AND LIMITS OF LAND TO BE USED TEMPORARILY
- LIMITS OF DEVIATION AND OF LAND TO BE ACQUIRED AND USED (SUBSOIL ONLY)
- LIMITS OF DEVIATION AND OF LAND TO BE ACQUIRED AND USED
- LIMITS OF LAND TO BE USED ONLY TEMPORARILY
- LIMITS OF LAND FOR PROTECTIVE WORKS
- COMMENCEMENT OF SCHEDULED WORK
- TERMINATION OF SCHEDULED WORK
- A ACCESS TO WORKS
- CENTRE LINE(S) OF SCHEDULED WORKS
- BOROUGH BOUNDARY

Based on Ordnance Survey Digital Data with the permission of H.M.S.O.
© Crown Copyright and database rights Ordnance Survey 100035791 / 035

PLAN

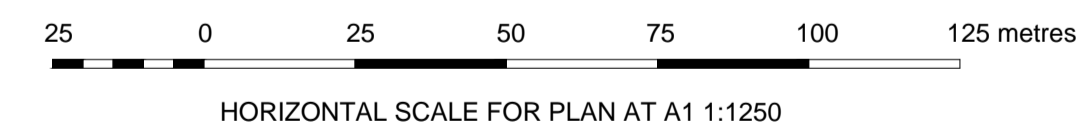

Transport and Works Act 1992 London Underground (Northern Line Extension) Order LONDON BOROUGH OF WANDSWORTH

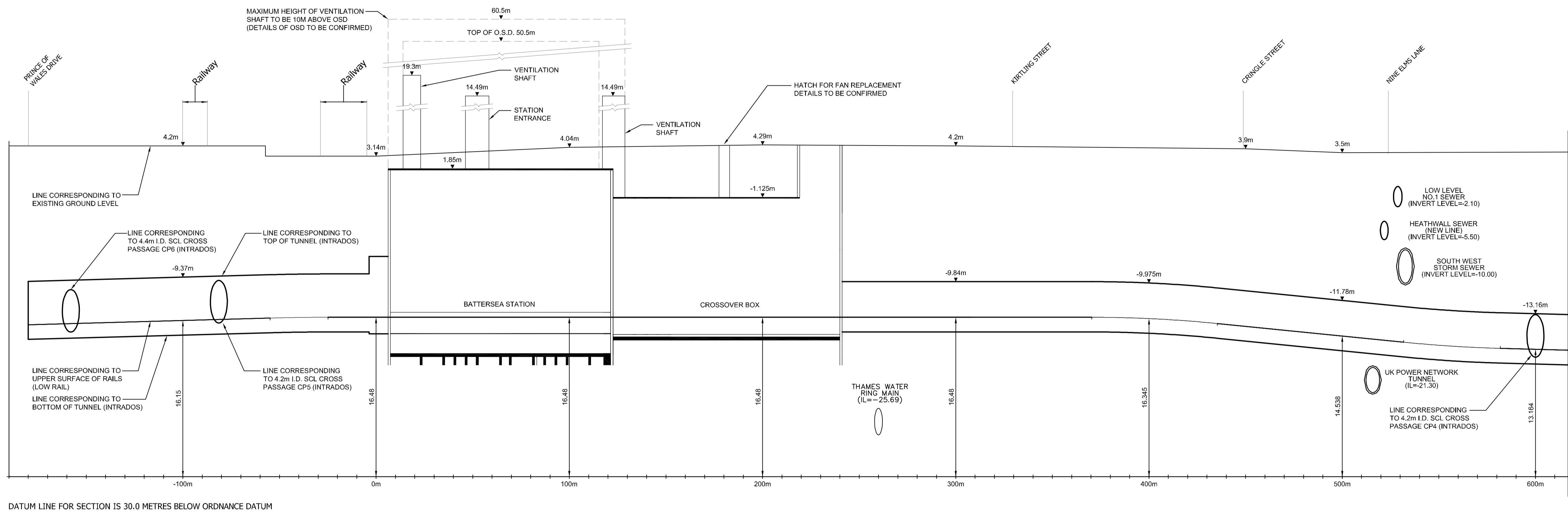

For Continuation See Sheet No. 9

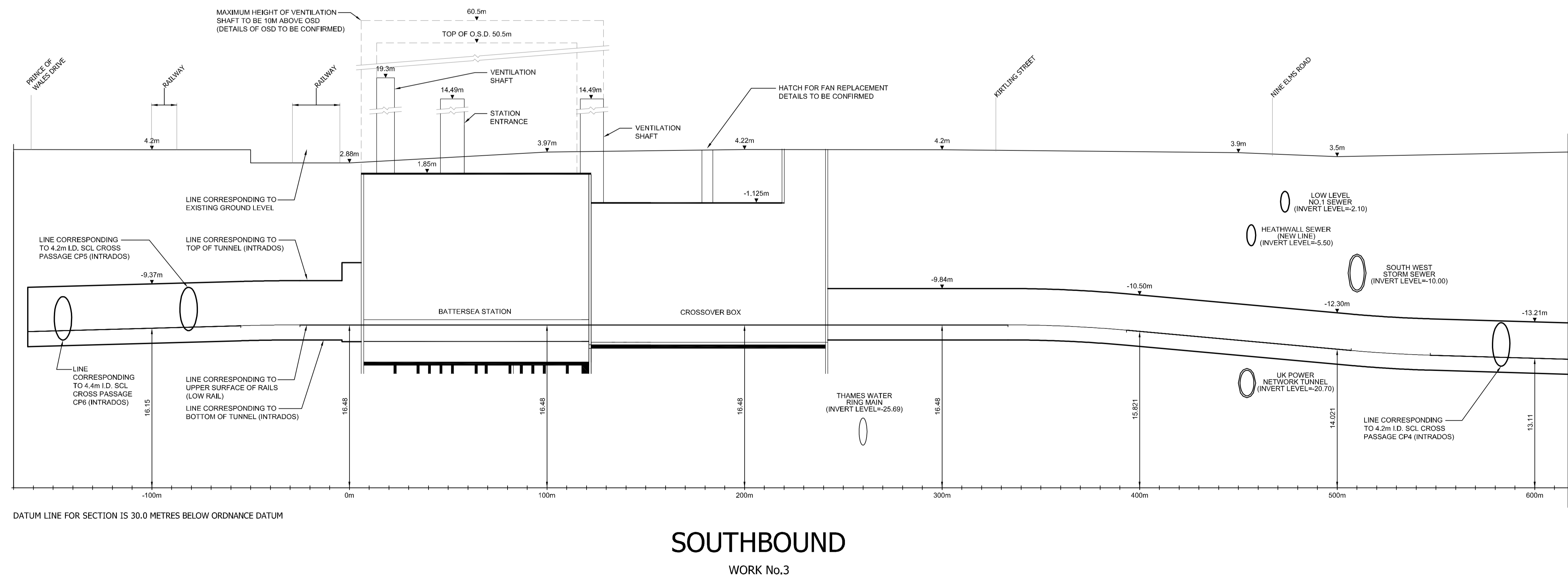

For Continuation See Sheet No. 9

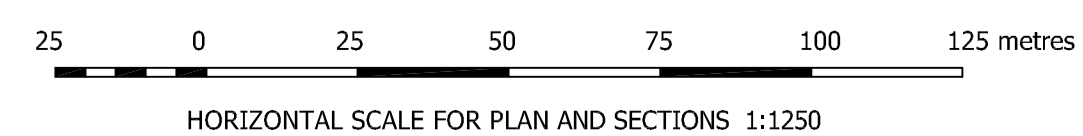

LONGITUDINAL SECTIONS

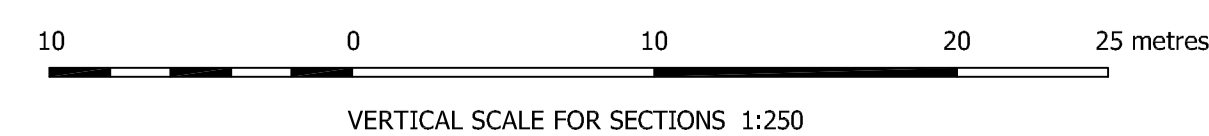

Transport and Works Act 1992
 London Underground (Northern Line Extension) Order
 LONDON BOROUGHS OF WANDSWORTH AND LAMBETH

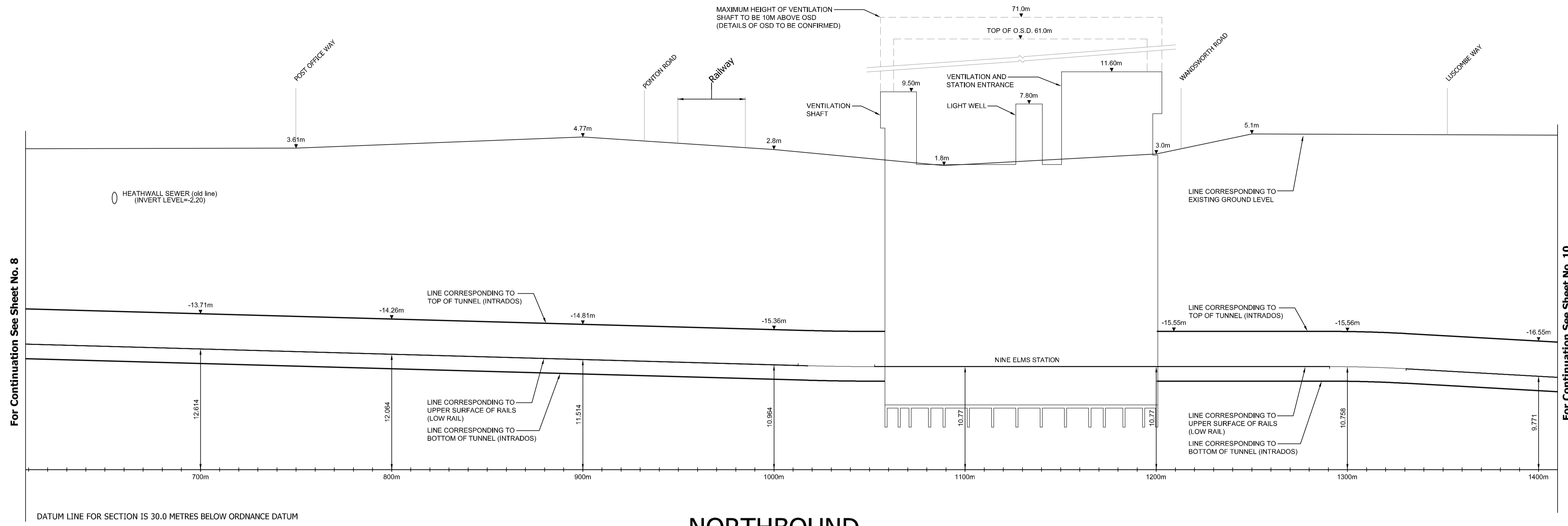

NORTHBOUND
 WORK No.3

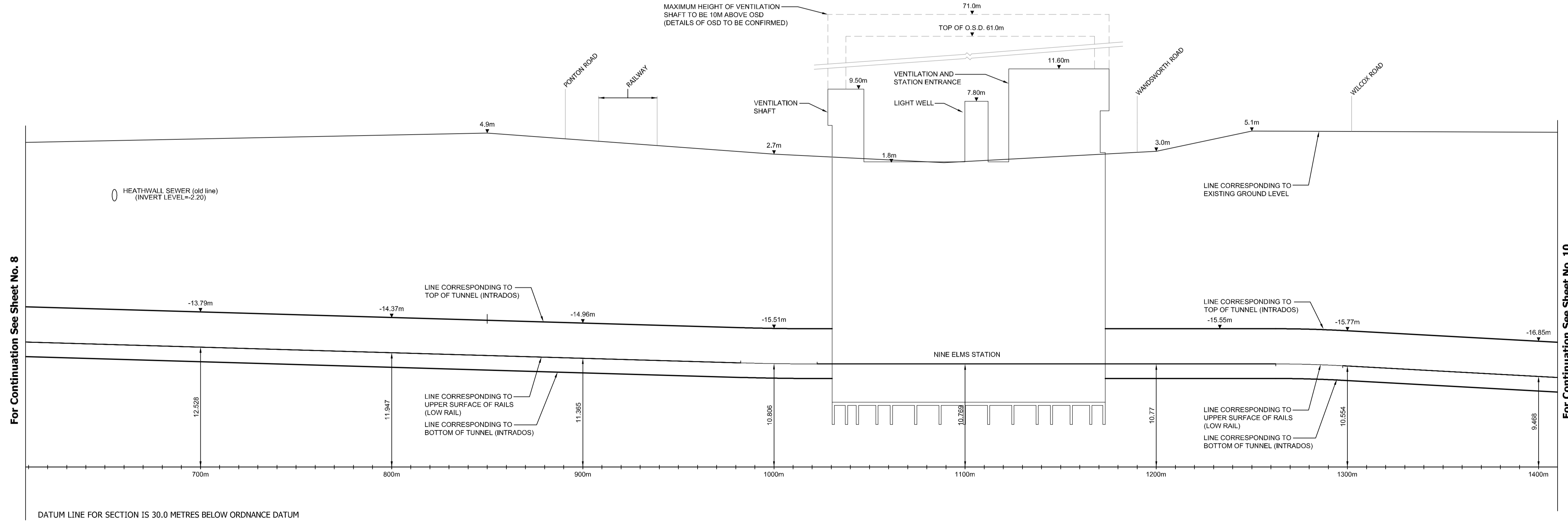

SOUTHBOUND
 WORK No.3

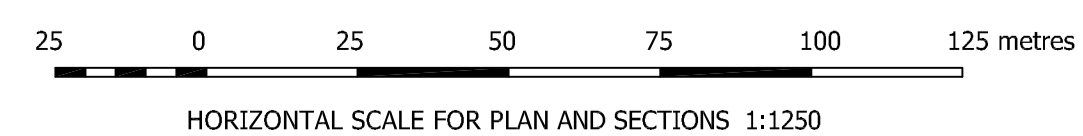

LONGITUDINAL SECTIONS

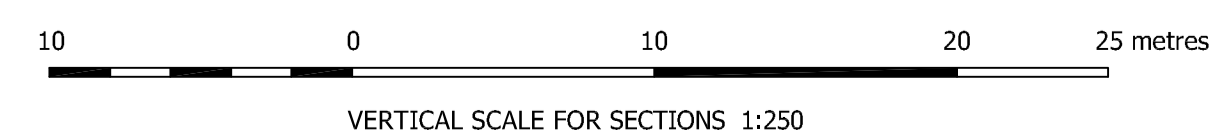

For Continuation See Sheet No. 8

For Continuation See Sheet No. 10

For Continuation See Sheet No. 8

For Continuation See Sheet No. 10

Transport and Works Act 1992 London Underground (Northern Line Extension) Order LONDON BOROUGH OF LAMBETH

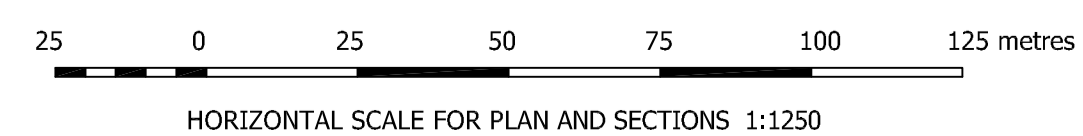
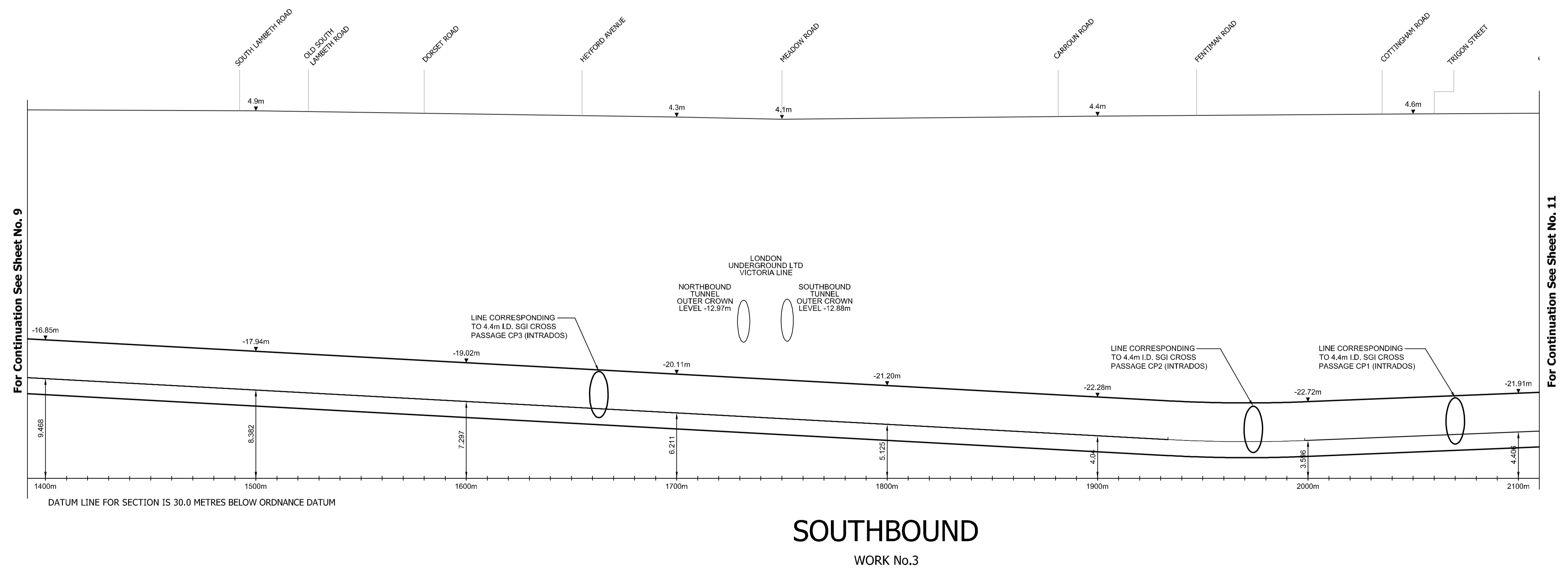
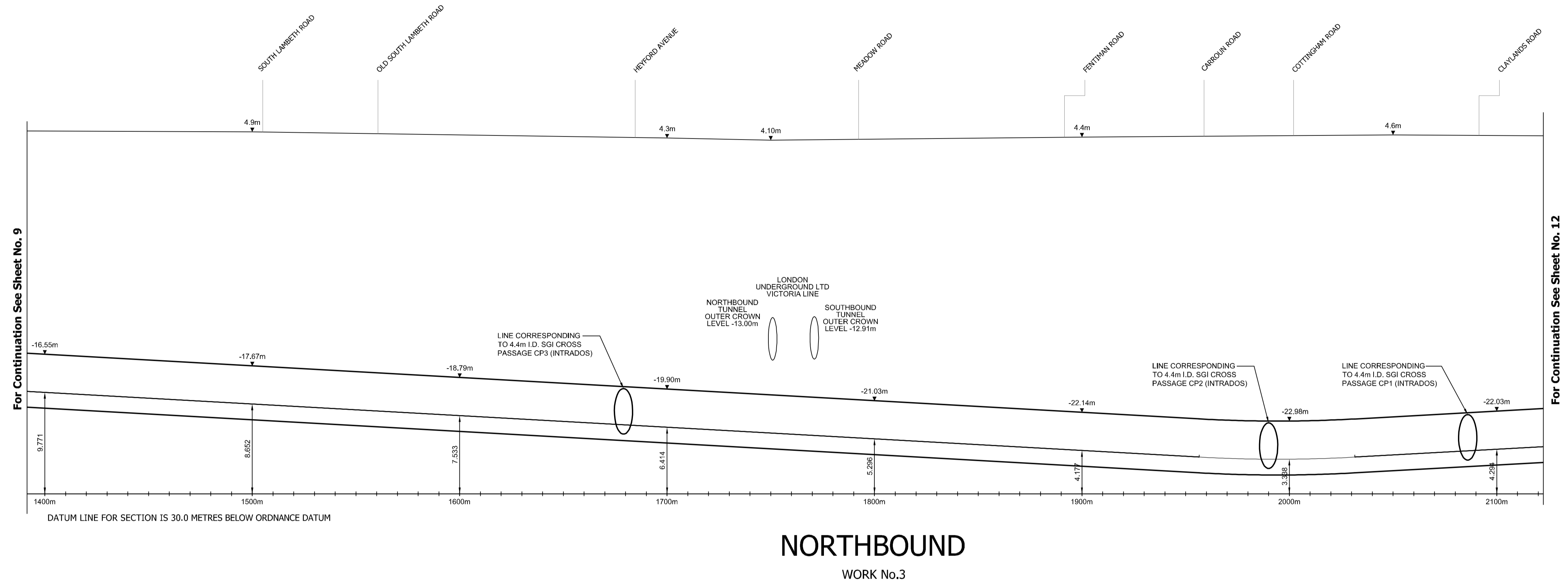

LONGITUDINAL SECTIONS

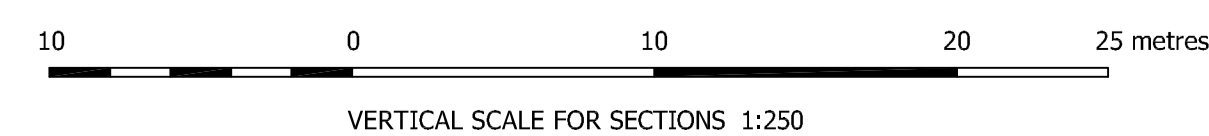

For Continuation See Sheet No. 9

For Continuation See Sheet No. 12

For Continuation See Sheet No. 9

For Continuation See Sheet No. 11

London Underground (Northern Line Extension) Order LONDON BOROUGHS OF LAMBETH AND SOUTHWARK

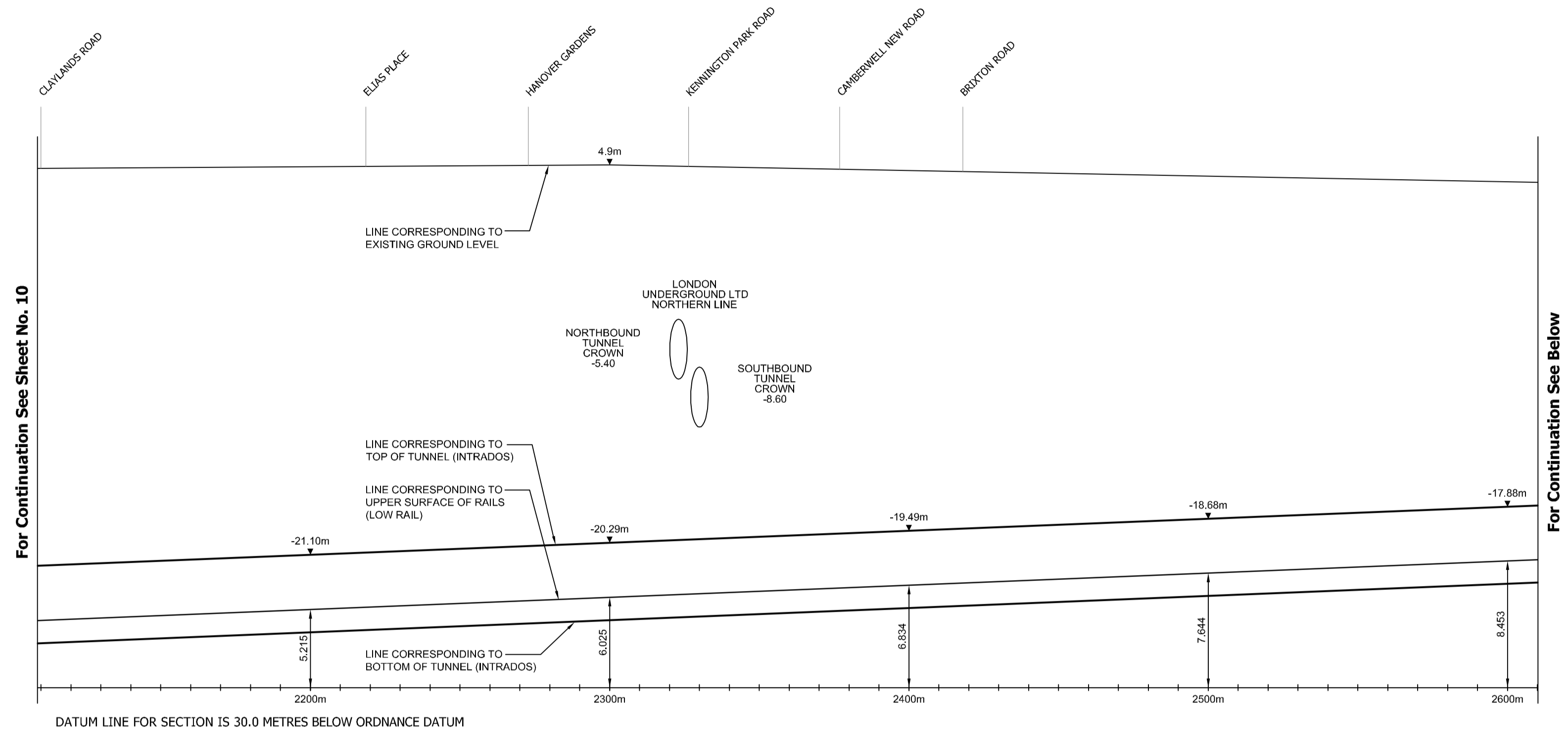

SOUTHBOUND

WORK No.1

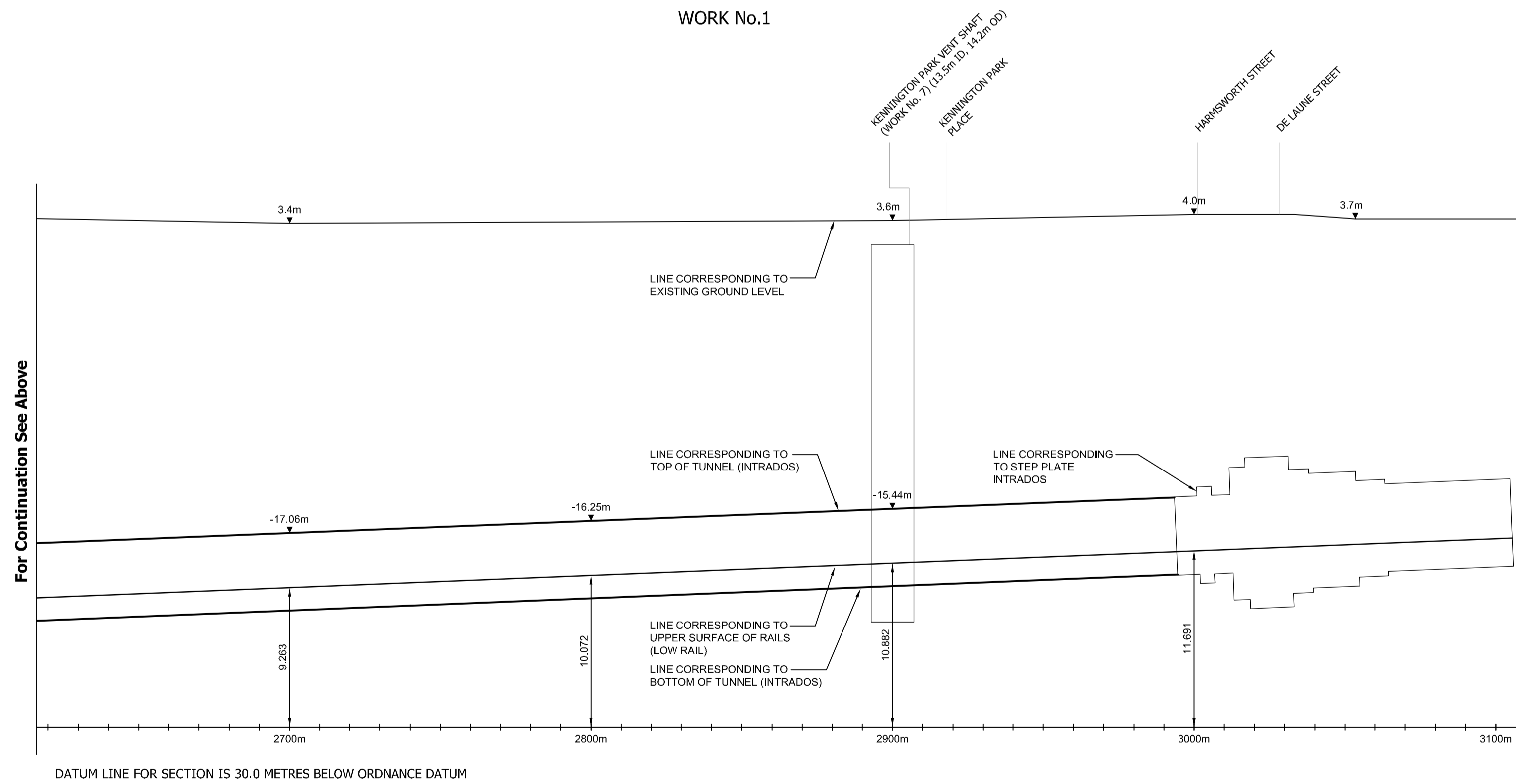

SOUTHBOUND

WORK No.1

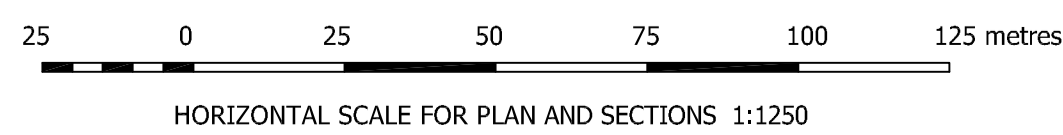

LONGITUDINAL SECTIONS

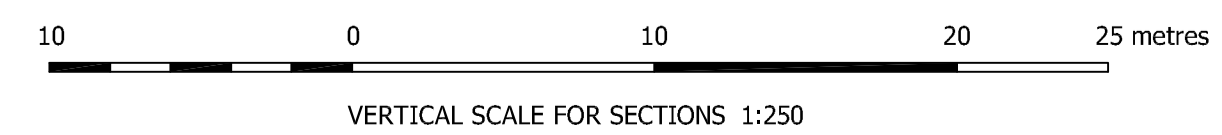

Transport and Works Act 1992

London Underground (Northern Line Extension) Order

LONDON BOROUGHS OF LAMBETH AND SOUTHWARK

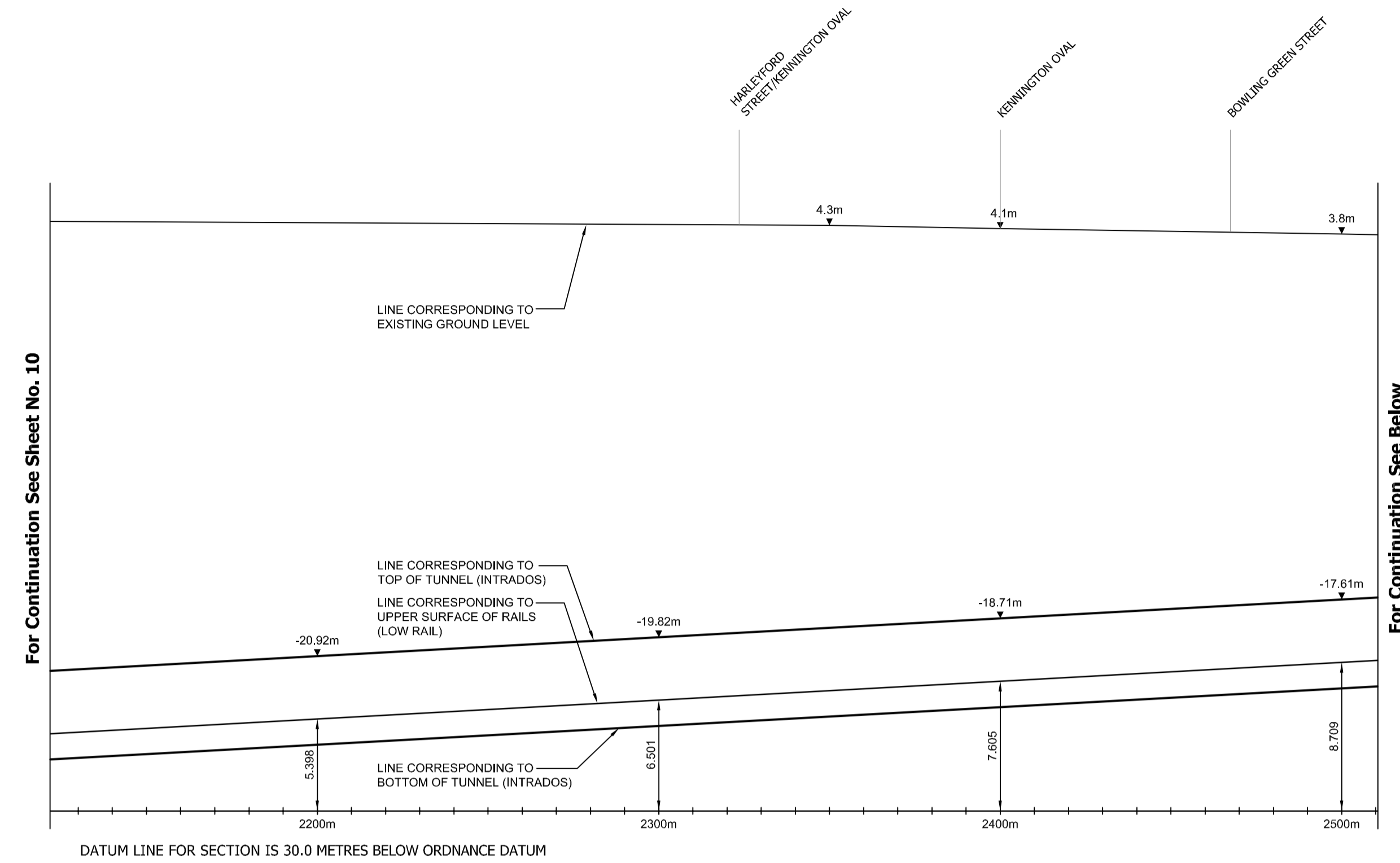

NORTHBOUND
WORK No.2

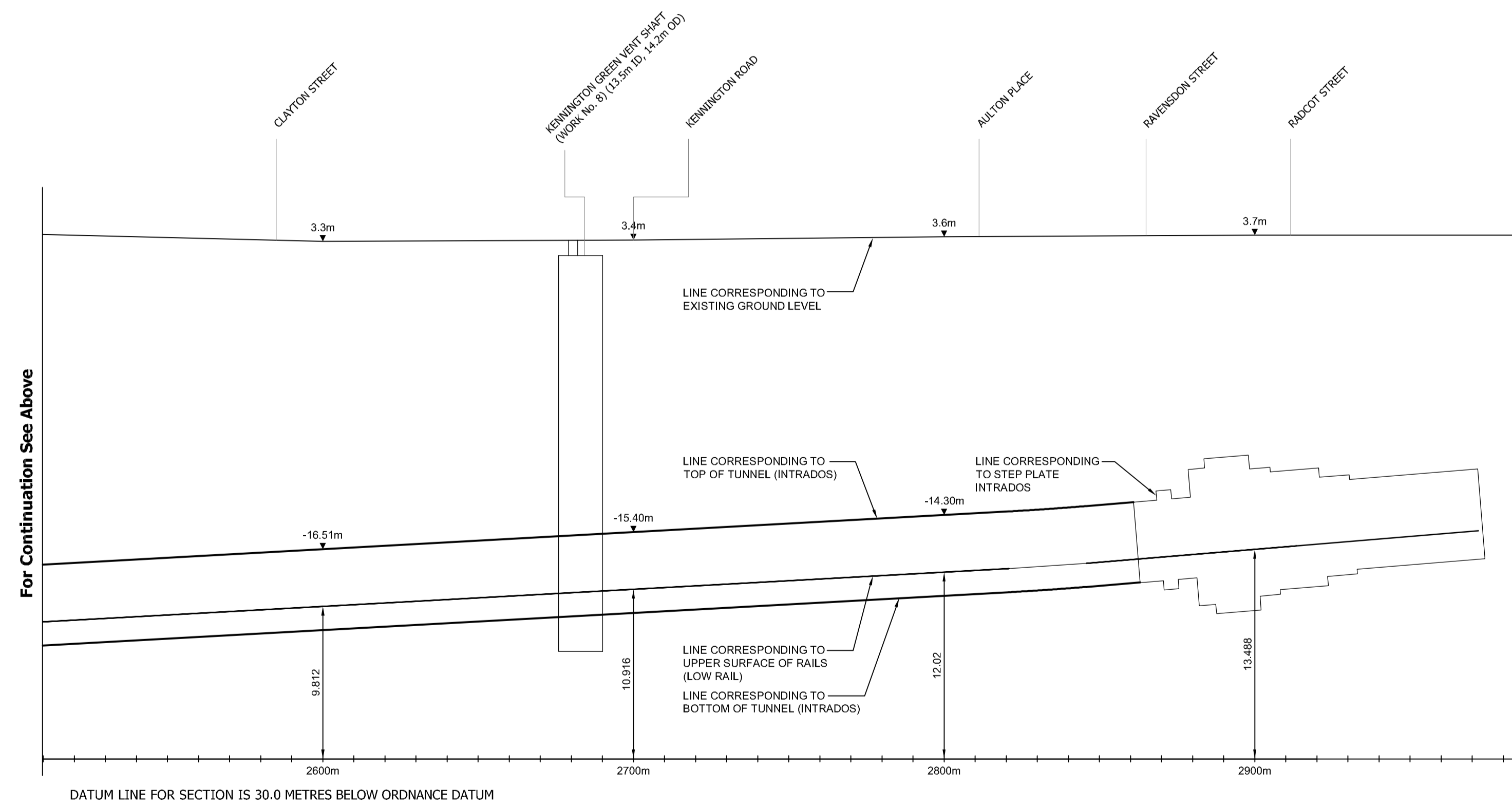

NORTHBOUND
WORK No.2

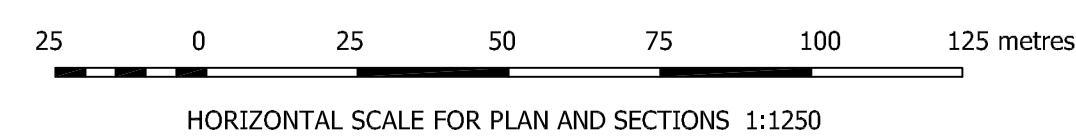

LONGITUDINAL SECTIONS

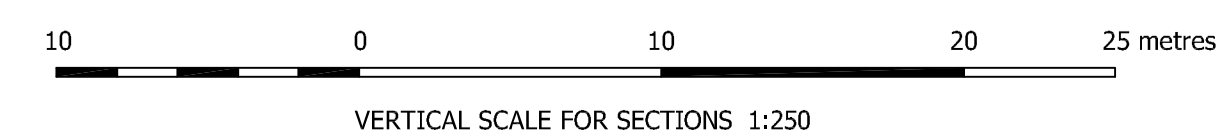

Transport and Works Act 1992 London Underground (Northern Line Extension) Order LONDON BOROUGH OF WANDSWORTH

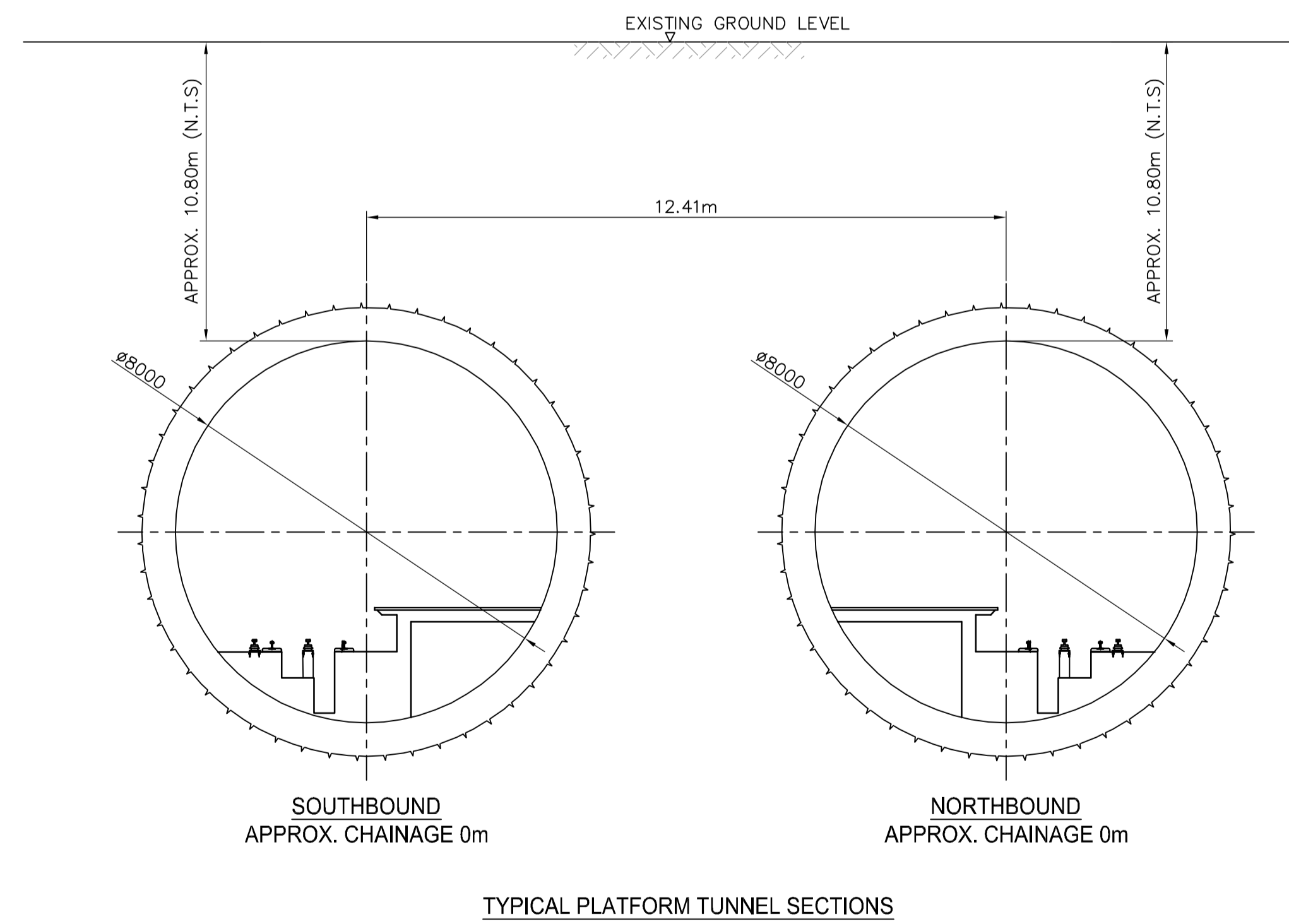
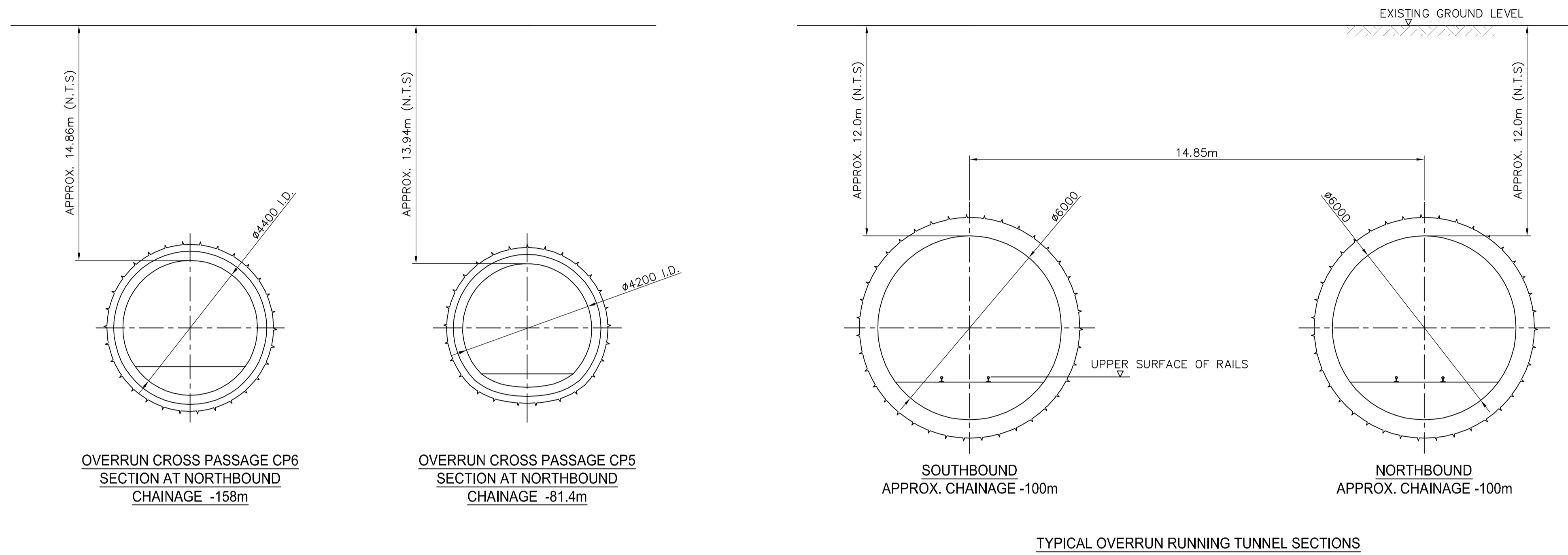

CROSS SECTIONS

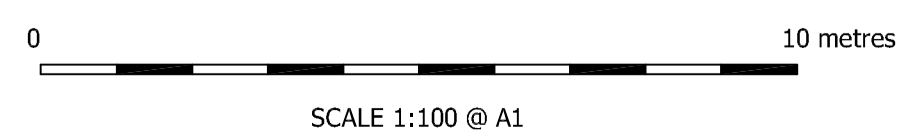

Transport and Works Act 1992

London Underground (Northern Line Extension) Order

LONDON BOROUGHS OF WANDSWORTH, LAMBETH AND SOUTHWARK

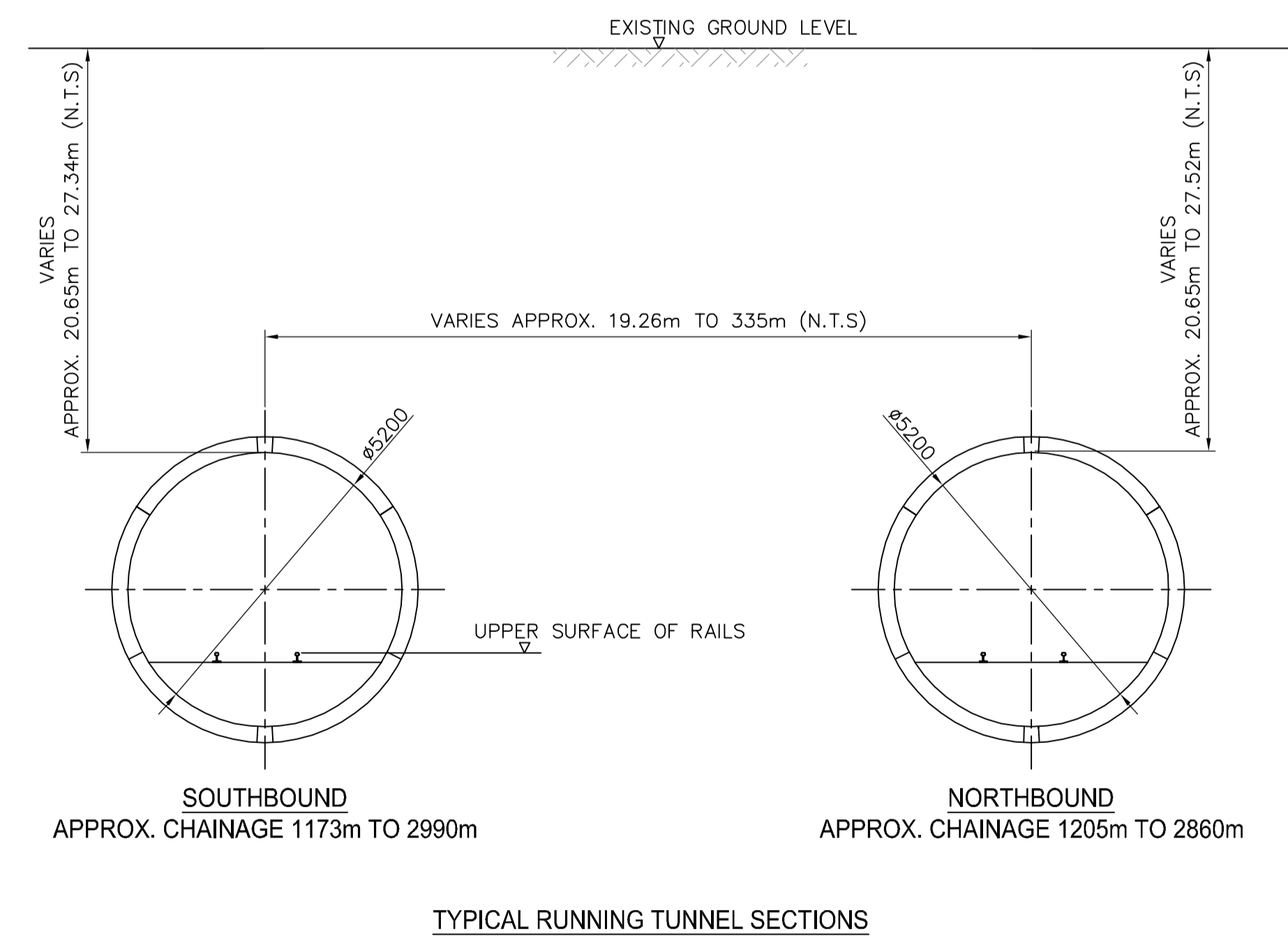
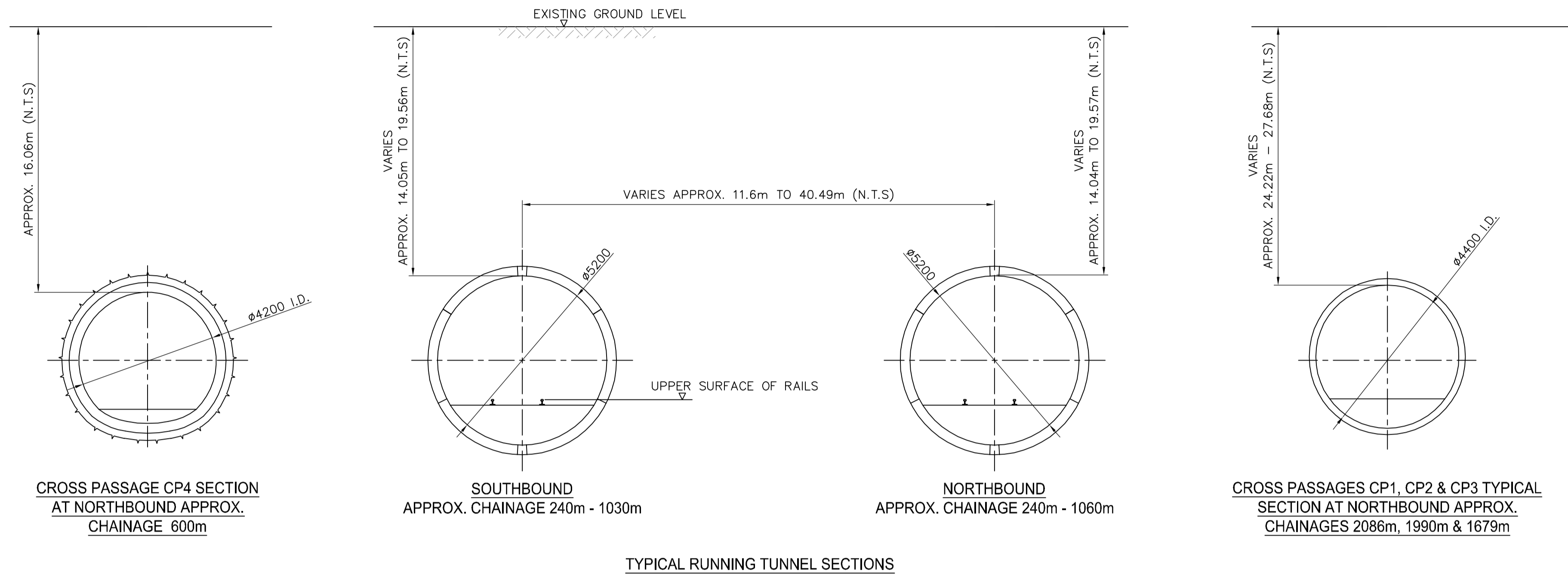

CROSS SECTIONS

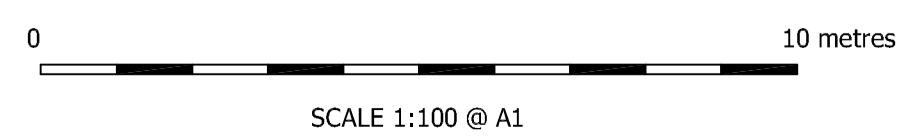

Transport and Works Act 1992 London Underground (Northern Line Extension) Order LONDON BOROUGHS OF LAMBETH AND SOUTHWARK

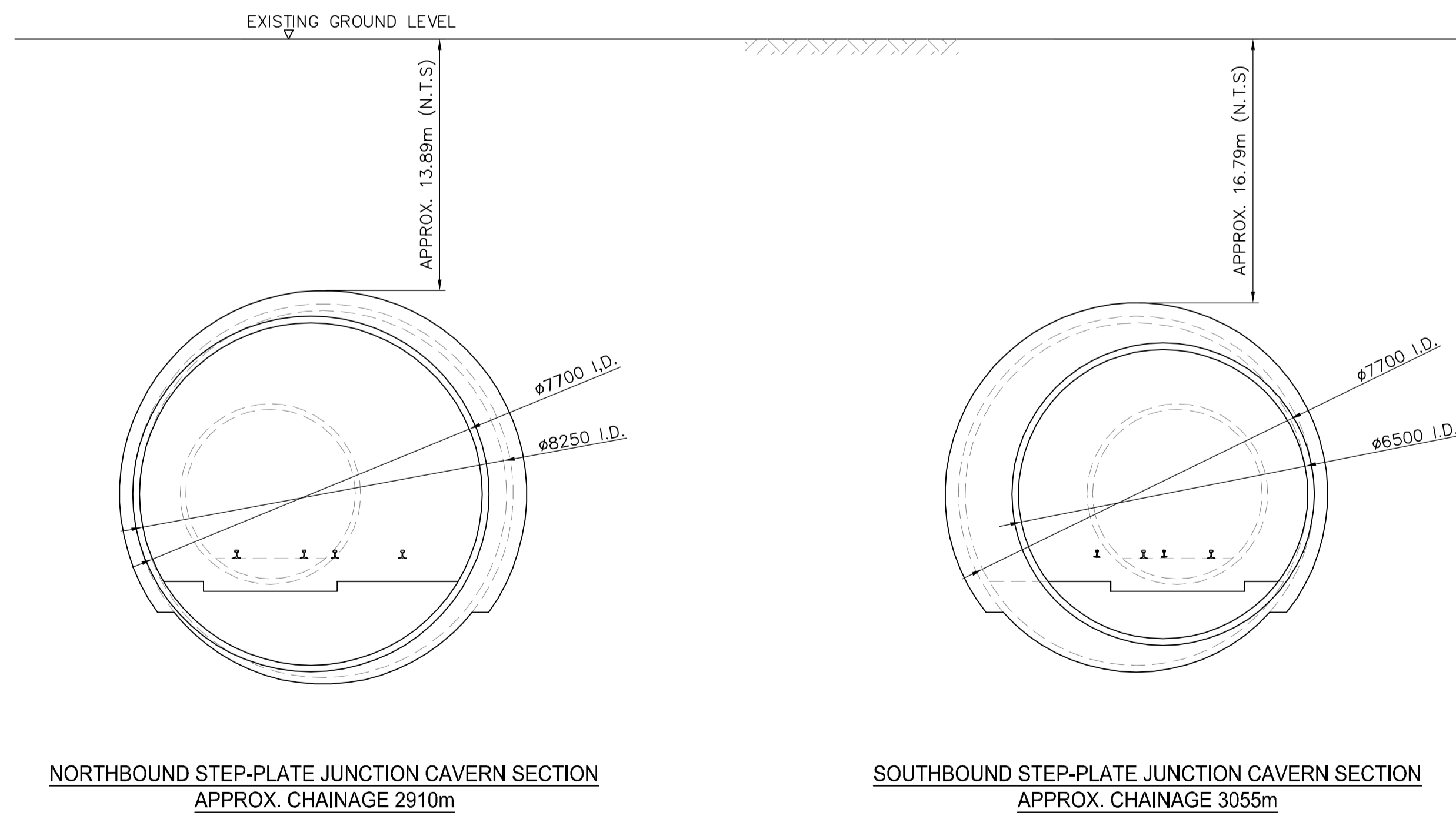

CROSS SECTIONS

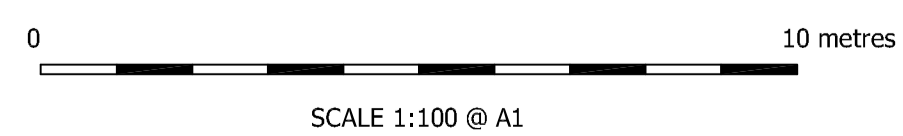

Transport and Works Act 1992
London Underground (Northern Line Extension) Order
LONDON BOROUGH OF LAMBETH

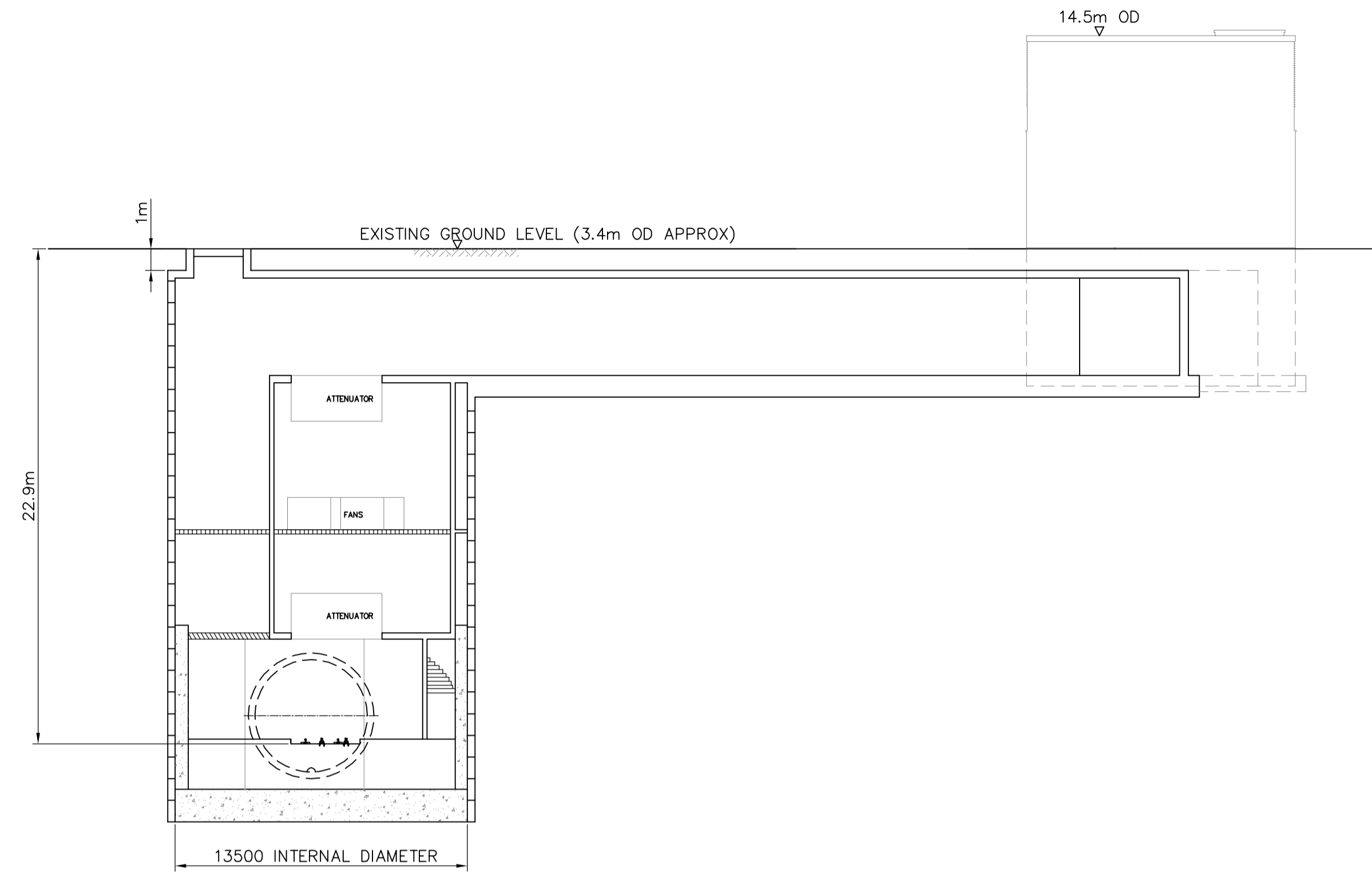

WORK No.8
KENNINGTON GREEN SHAFT SECTION
LOOKING SOUTH WEST

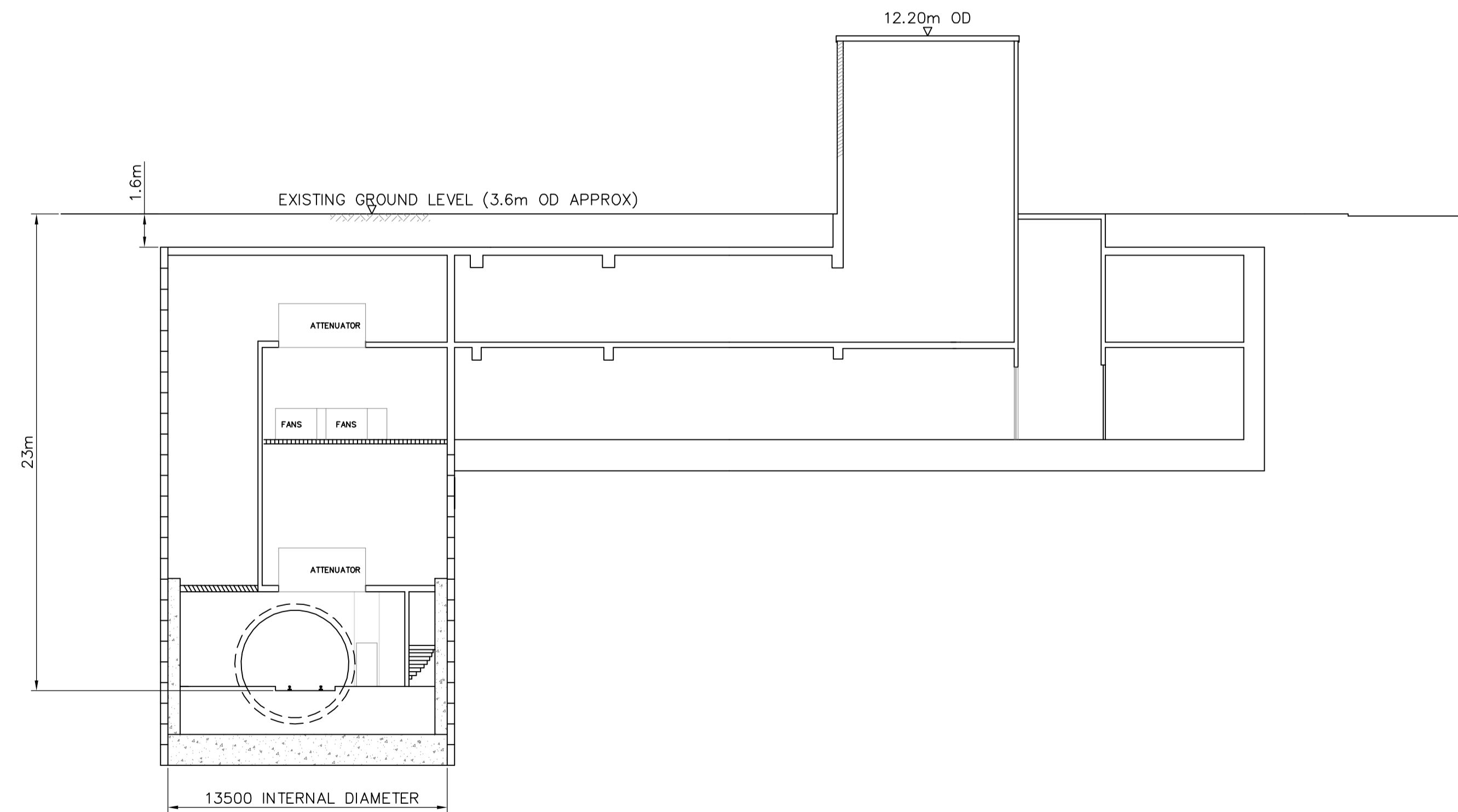

WORK No.7
KENNINGTON PARK SHAFT SECTION
LOOKING NORTH EAST

LONGITUDINAL SECTIONS AND CROSS SECTIONS

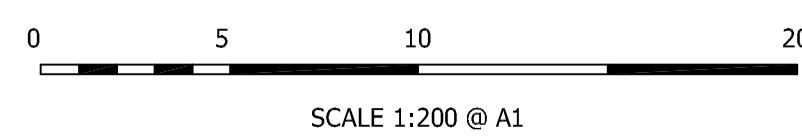

Transport and Works Act 1992
 London Underground (Northern Line Extension) Order
 LONDON BOROUGHS OF LAMBETH AND SOUTHWARK

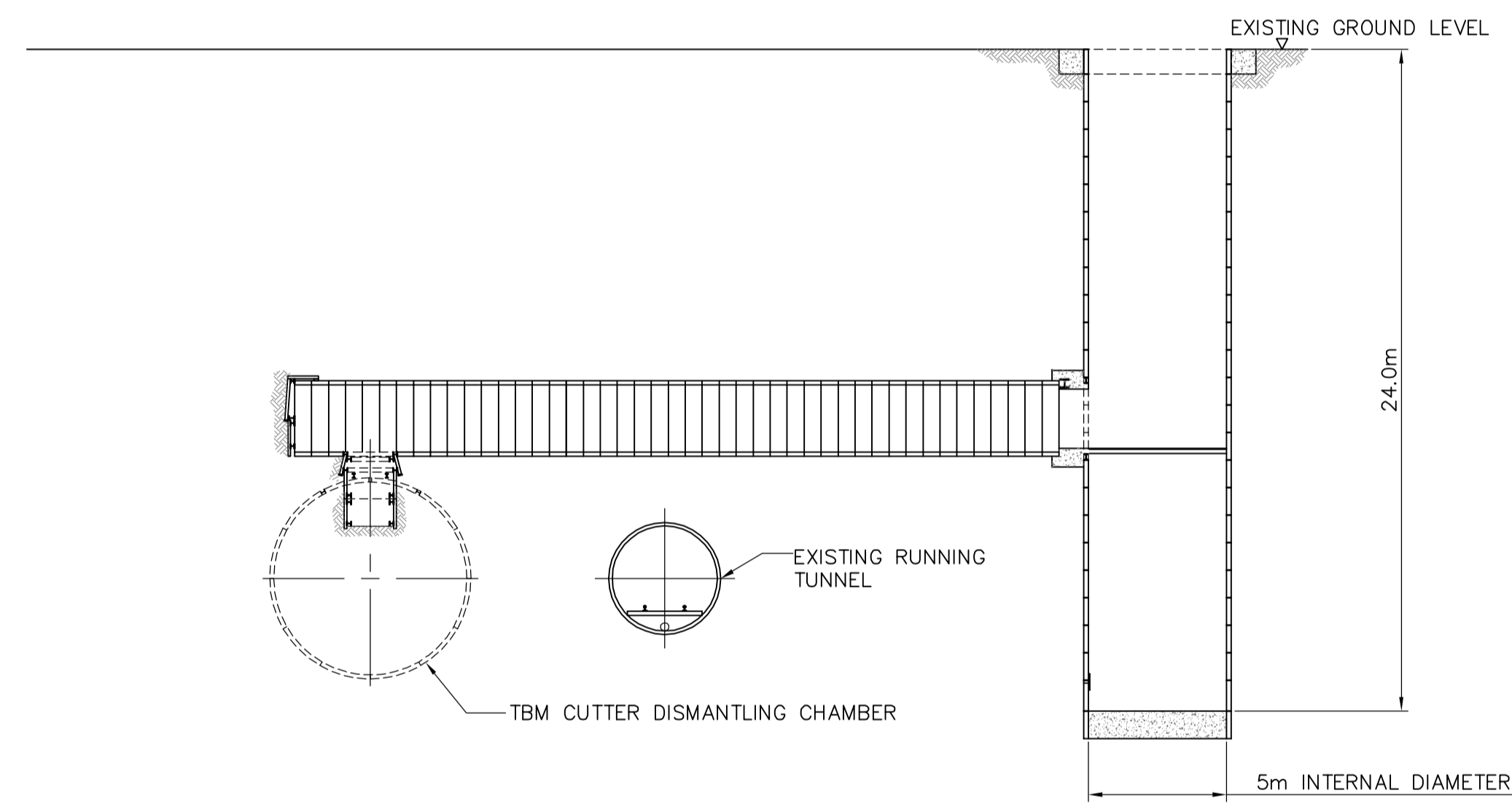

WORK No.6
 RADCOT STREET
 TEMPORARY GROUTING SHAFT AND ADIT SECTION
 LOOKING NORTH

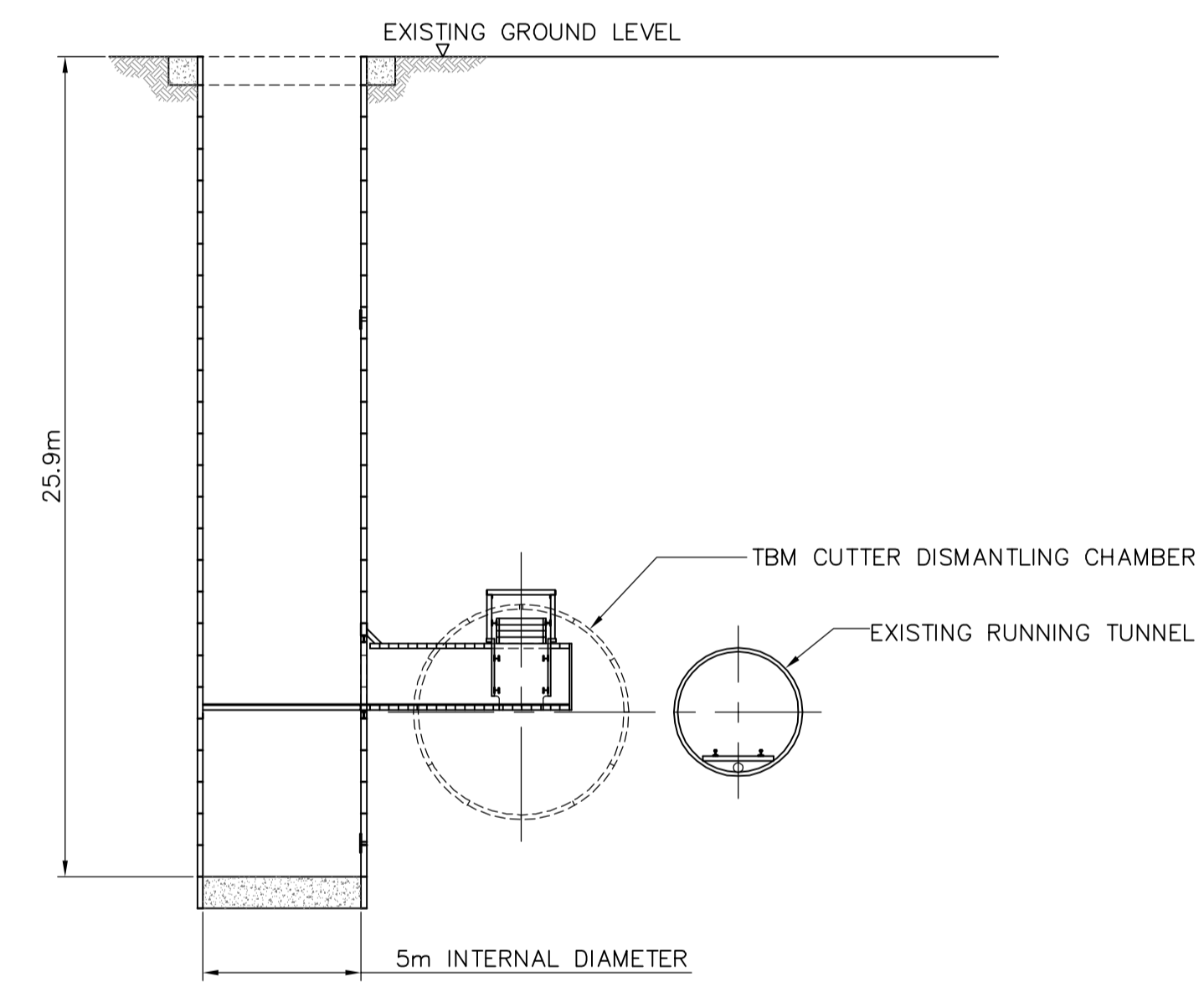

WORK No.5
 HARMSWORTH STREET TEMPORARY
 GROUTING SHAFT AND ADIT SECTION
 LOOKING SOUTH WEST

LONGITUDINAL SECTIONS AND CROSS SECTIONS

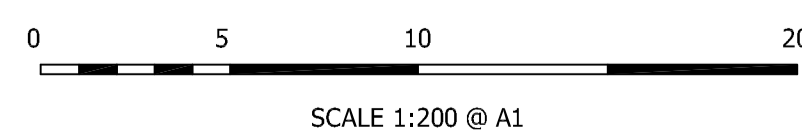

Transport and Works Act 1992

London Underground (Northern Line Extension) Order

LONDON BOROUGHS OF WANDSWORTH AND SOUTHWARK



WORK No.9
BATTERSEA STATION TEMPORARY ROAD
LOOKING WEST

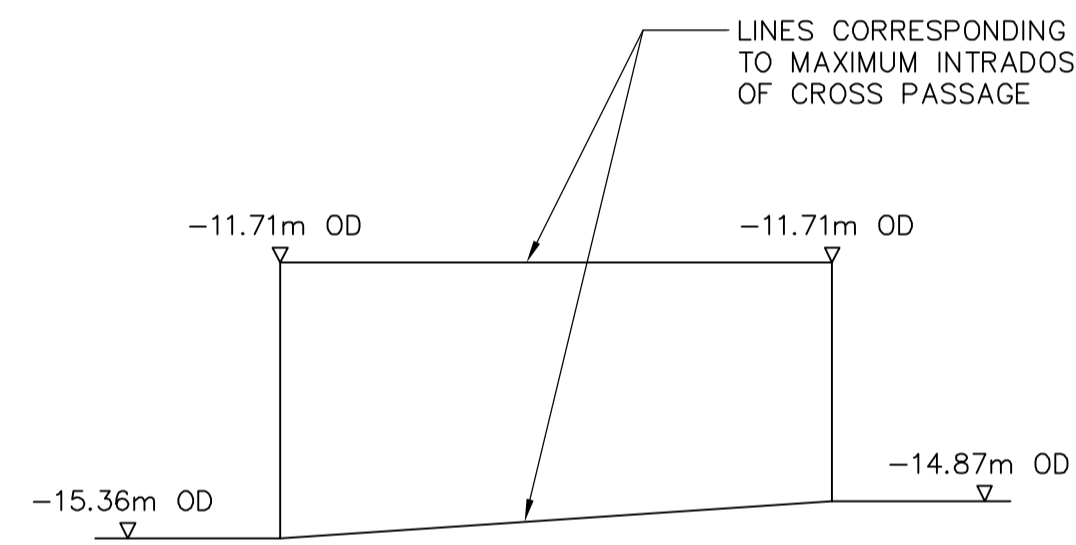

WORK No.4a
KENNINGTON STATION CROSS PASSAGE
LOOKING NORTH EAST

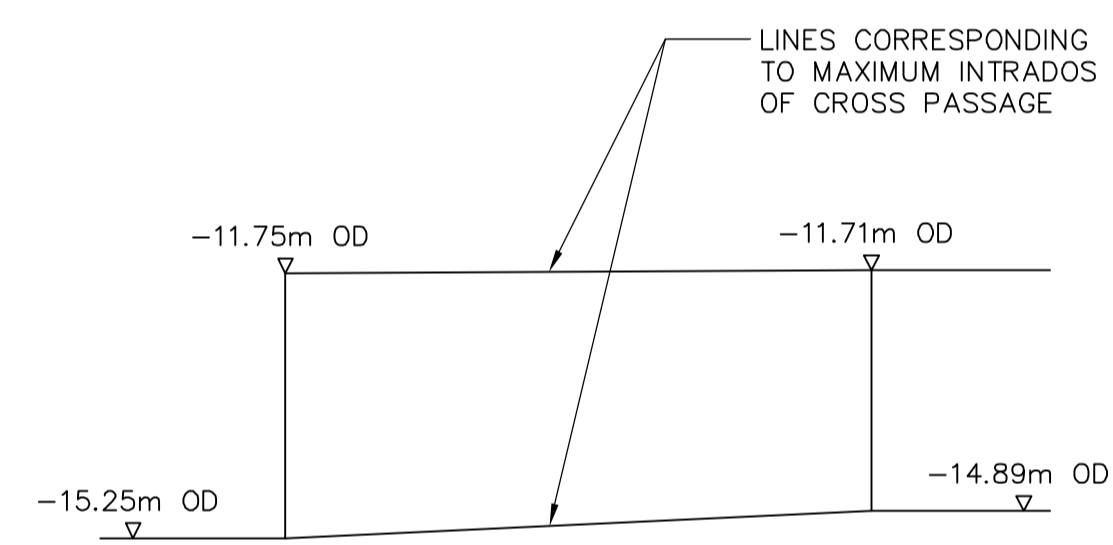

WORK No.4b
KENNINGTON STATION CROSS PASSAGE
LOOKING NORTH EAST

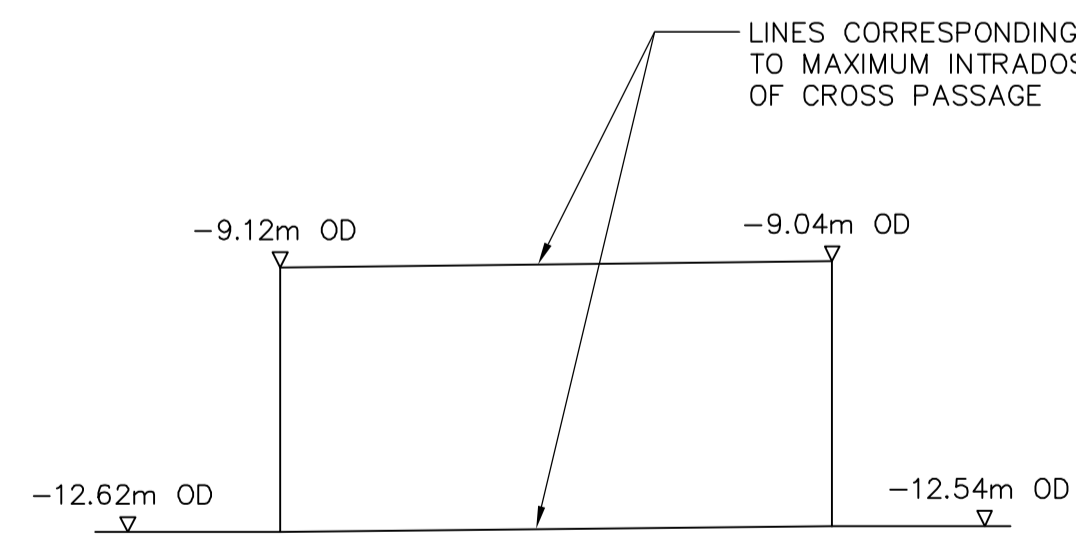

WORK No.4c
KENNINGTON STATION CROSS PASSAGE
LOOKING NORTH EAST

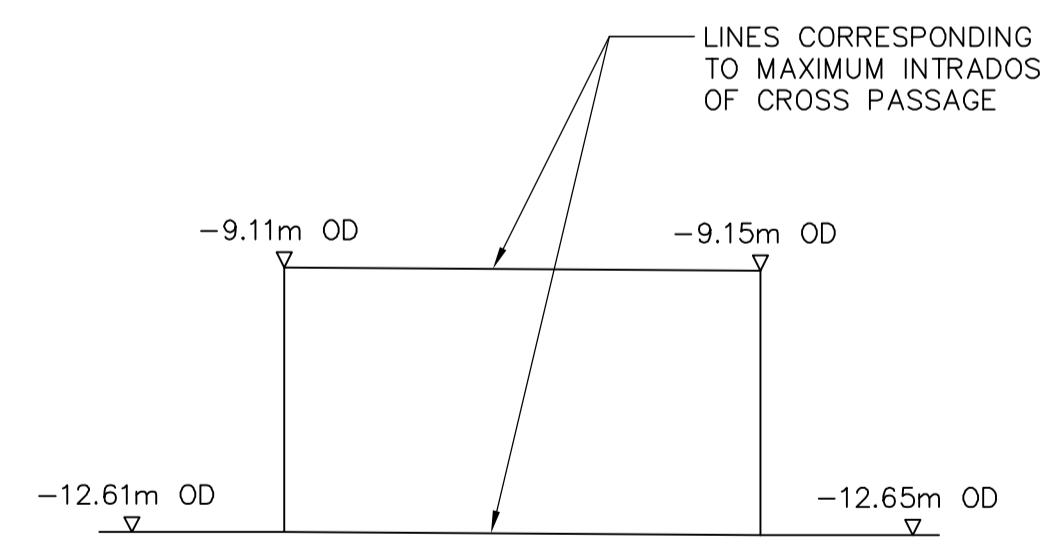

WORK No.4d
KENNINGTON STATION CROSS PASSAGE
LOOKING NORTH EAST

LONGITUDINAL SECTIONS

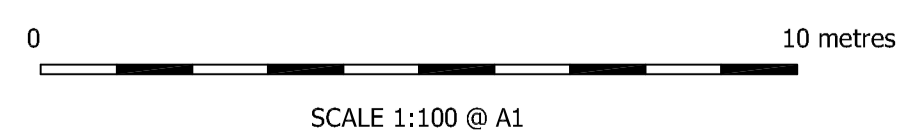

Transport and Works Act 1992

London Underground (Northern Line Extension) Order

LONDON BOROUGH OF WANDSWORTH

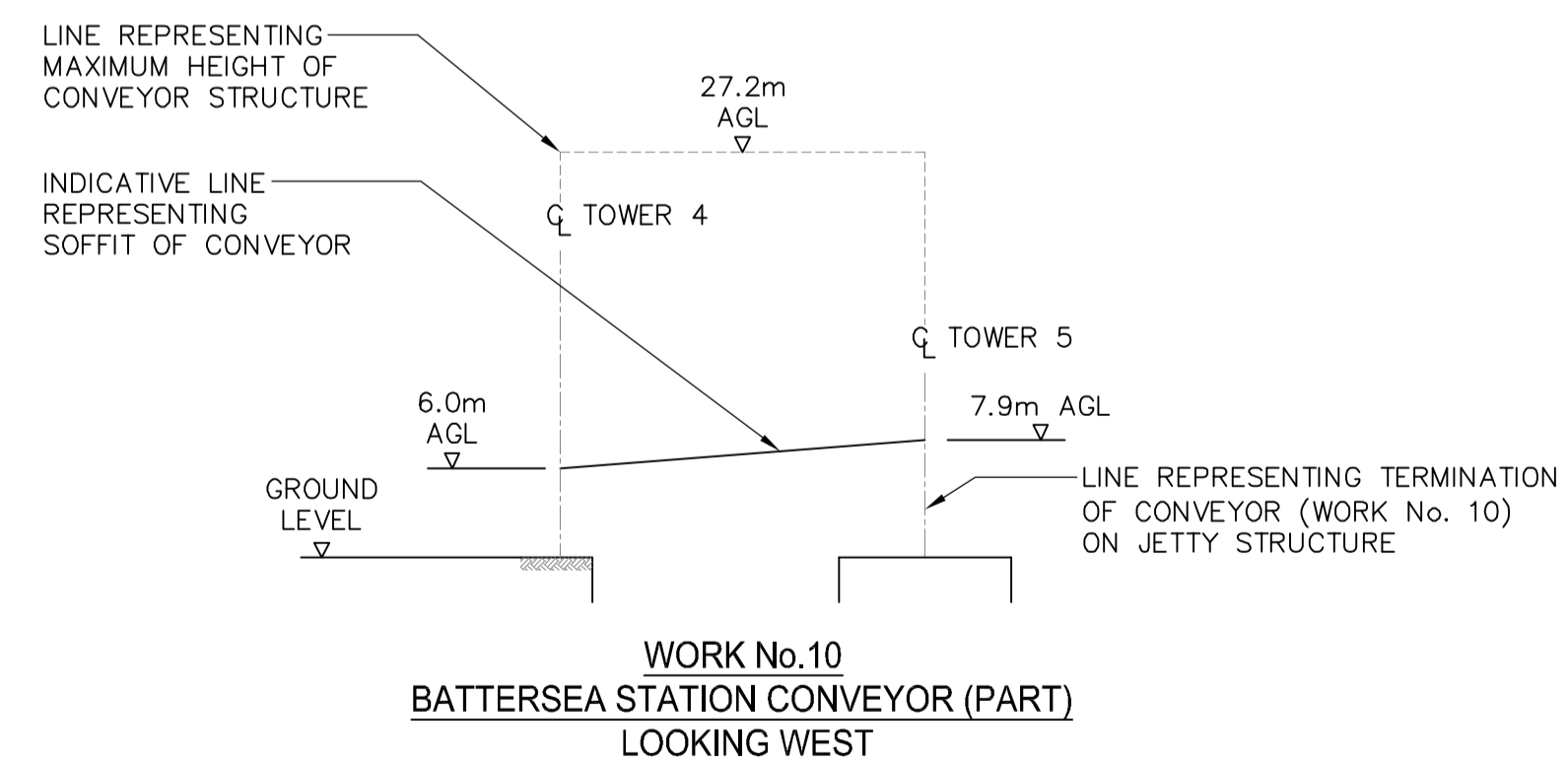
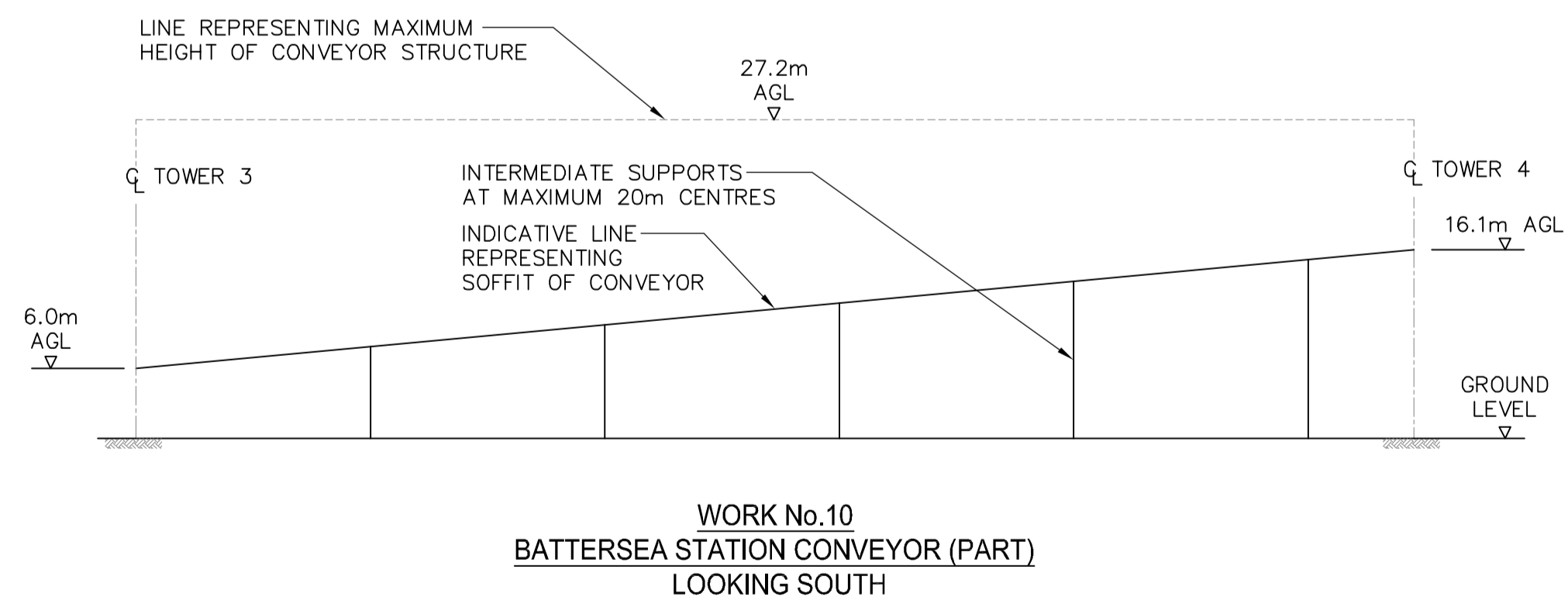
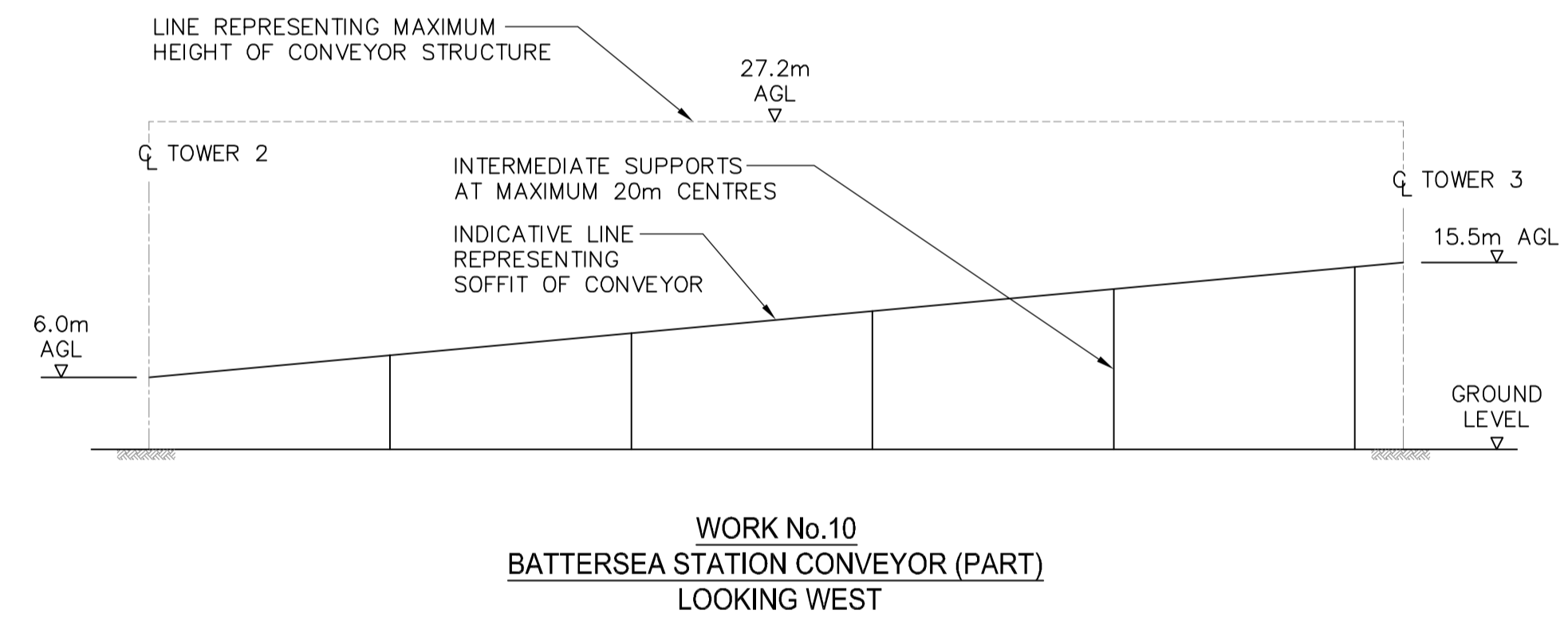
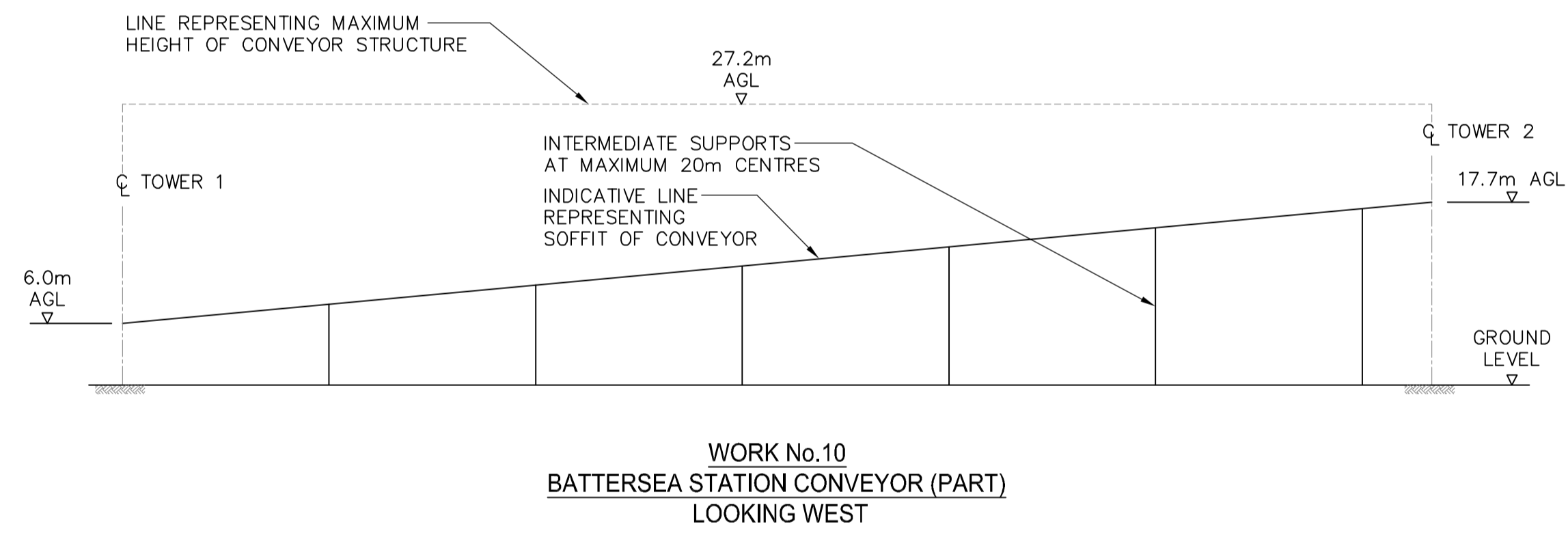
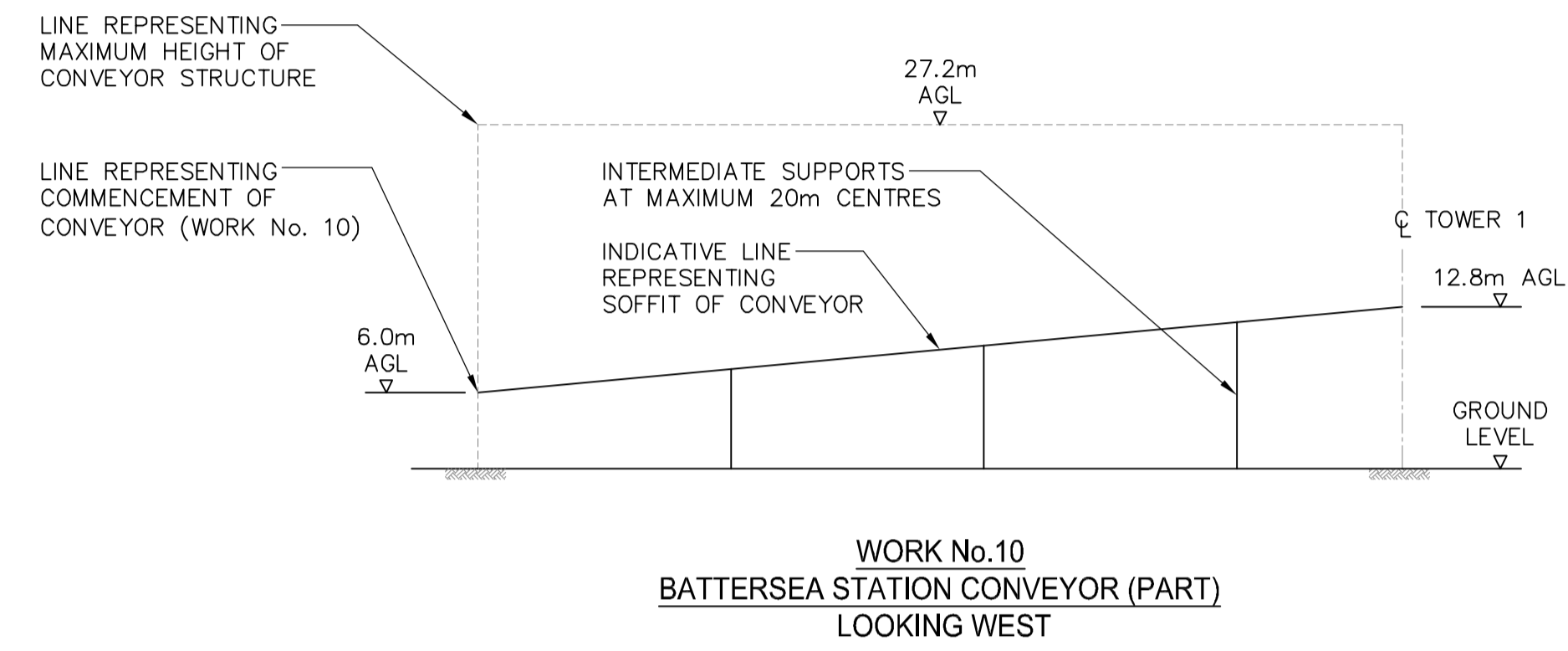
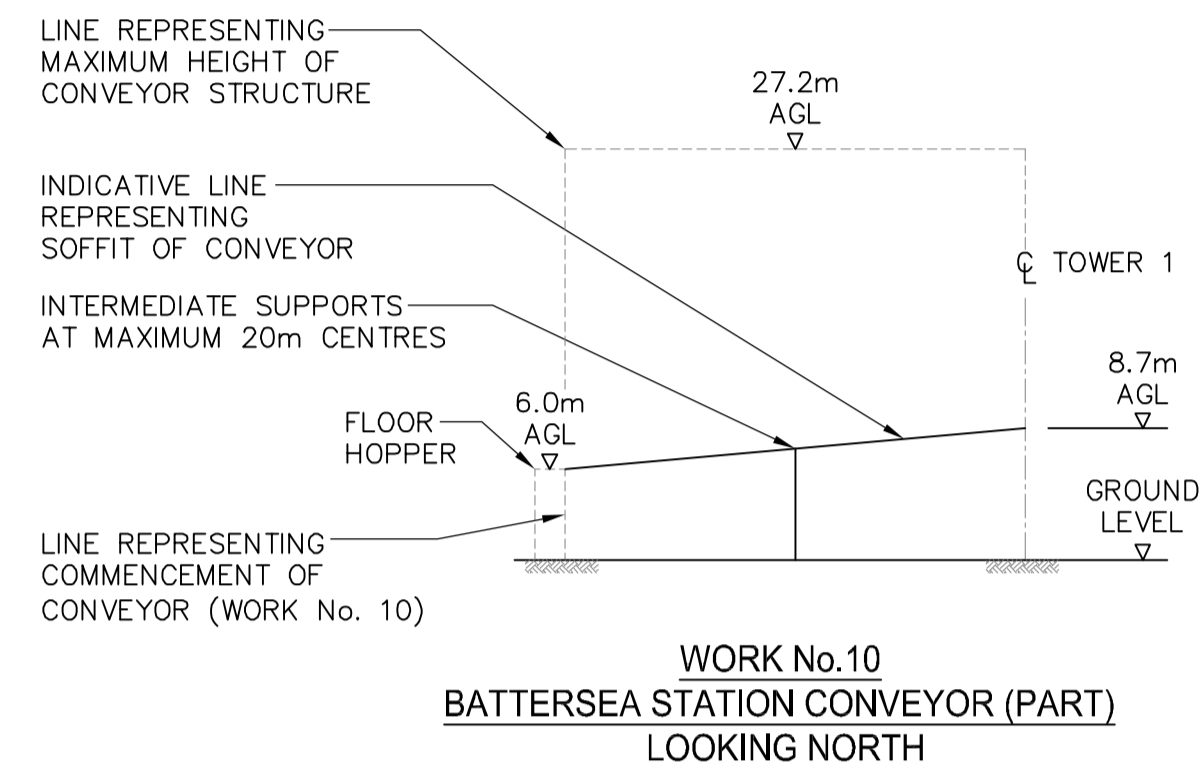

LONGITUDINAL SECTIONS

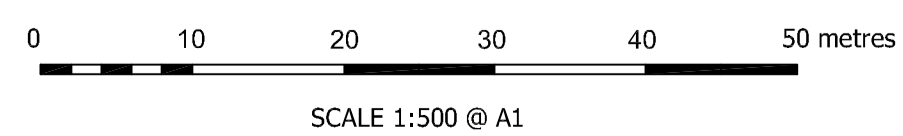



Buro Happold

CORDEROY

Halcrow

JOHN MCASLAN + PARTNERS



 **steer davis gleave**

studiodareARCHITECTS

URS

